

cps[®]

CONVERT-ABLE FA1234 REFRIGERANT RECOVER / RECYCLE / EVACUATION AND RECHARGE UNIT

**Convertible between four
refrigerants: R-134a,
R-1234yf, R-22 and
R-407C**

Unit covered under US Patent
8,082,750 and other patents
pending.



OPERATION MANUAL

Export Models: FA1234, FA1234A, FA1234E, FA1234K

Unit Consists Of:

- FA1234 Series Mach 7 Automotive Refrigerant Recover / Recycling / and Recharge Machine
- 6 CFM 50 micron vacuum pump
- Recovery Cylinder - FA1234 series includes a 50 lb DOT storage tank, FA1234E does not include a storage tank. User must use country approved storage tank
- Interchangeable Low and High side R-134a and R-1234yf couplings for easy conversion
- Built-in oil injection system
- 2 tank refill adaptors, 1/2" ACME RH Female for R-134a, 1/2" ACME LH Female for R-1234yf
- R-1234yf conversion fittings for hose storage and oil flush block
- 41 cubic Inch CPS filter drier (Replacement part number ARXF5)
- Tank filter bracket with hardware and all tank hoses if the tank is not included
- 1 lb (454 gram) check weight
- Operation manual

End user to provide:

- R-134a, R-1234yf, R-22, or R-407C refrigerant (for R-22 and R-407C refrigerant, user will need to purchase HP8RE and HP8BE service hoses)
- Refrigerant oil and/or dye for injection system

Table of Contents

Specifications.....	2
Introduction.....	3
General Safety Instructions.....	4
Initial Equipment Preparation.....	5
Initial Set-Up.....	6
Refrigerant Conversion.....	7-8
Operating Instructions.....	9-18
Maintenance.....	19-24
Service Parts and Accessories.....	25
High Voltage Charging / Trouble Shooting Chart.....	26
Warranty and Contact Information.....	27

FA1234 Specifications			
Models	FA1234	FA1234A / FA1234E	FA1234K
Compressor Type	2/3 HP oil-less reciprocating compressor		
Dimensions	22" W x 24.5" D x 42" H		
Weight	100 lbs (does not include tank weight)		
Operating Range	10°C (50°F) to 49°C (120°F)		
Power Source	115 VAC 60Hz 1Ph	220 - 240 VAC 50Hz 1Ph	220 VAC 50Hz - 230 VAC 60Hz 1Ph
Power Consumption	750 W		
Low Side Gauge	-30 inch Hg to 125 PSIG		
High Side Gauge	0 to 500 PSIG		
Filtration	41 cubic inch drier, .7 micron oil separator		
Automatic Control Valves	Patented motorized ball valves to control HI, LO, recover, and vacuum		
Charging Valve	12 VDC Solenoid Valve		
Construction	1" Heavy duty tubular frame construction 10" pneumatic wheels, 4" swivel casters		
Overload Protection	15A Thermal Breaker	15A Thermal Breaker	10A Thermal Breaker
High Pressure Shut-Off	30 bar (450 psig)		
Refrigerants	R-134a, R-1234yf, R-22 and R-407C		

INTRODUCTION

Thank you for purchasing the **CPS Convertible FA1234** series unit. CPS has integrated its latest patent pending technology and incorporated state of the art features while improving reliability and performance. The unit includes a procedure for charging High Voltage Compressor system used in many hybrid vehicles.

The FA1234 can also handle contaminated refrigerants with its special pumpdown and complete evacuation process. It gives the end user a truly one machine meets all needs.

The FA1234 series primary use is an Automotive R/R/R unit. The FA1234 automatically recovers, recycles, evacuates, and recharges mobile A/C systems. Simply hook up the service hoses, choose the desired operation, and allow the unit to automatically complete the A/C service.

The FA1234 utilizes a single pass (oil coalescing, particle filtration, and moisture removal) recycling system, which means that whenever the FA1234 recovers, it also recycles. The unit also incorporates automatic air purge to remove unwanted non-condensable gasses from the refrigerant. Thus the refrigerant storage tank always contains the cleanest refrigerant possible for future recharge use.

The FA1234 utilizes CPS's patented motorized ball valves. The motorized ball valves are unique to the industry in that they will not be affected by sealants, particulates, and other contaminants. The motorized ball valves incorporate passage ways 8-15 times larger than the existing solenoid valves orifice technology. In fact the FA1234 uses no solenoid or check valves in the active flow path during recovery or evacuation, thus enhancing speed.

The FA1234 utilizes CPS's patent pending two cylinder oil-less compressor. This compressor improves reliability and performance. Being oil free, no compressor oil maintenance or oil return system is required.

The following are additional features:

- Integrated manifold gauge set. Visually see how the mobile A/C system is operating. No manual valves to open or close
- Large Graphic LCD to view operating instructions. Languages include English, Spanish, French, German, Chinese and more
- A highly accurate electronic charge scale
- Microprocessor Integrated mass flow system keeps track of how much refrigerant has run through the filter drier giving the user maximum amount of run time on each filter (150 LBS per filter)
- Cartridge type 41 inch cubic filter drier. Mounted directly on the storage cylinder for optimal moisture removal and weight accuracy
- Automatic high-pressure shut-off with microprocessor indication
- Interchangeable CPS Recovery cylinders. Use your country's approved refrigerant cylinders. The software allows the user to set up the proper tank and refrigerant parameters. Larger cylinders, such as CPS CRX390T, can be used for larger truck and bus A/C systems.
- Modular design for easy replacement of a defective plumbing, scale, electronic, compressor or vacuum pump sub system
- Heavy-duty construction: Powder coated steel cabinet mounted onto a 1" tubular steel frame
- 10" pneumatic rear wheels and 4" swivel casters give this unit excellent maneuverability under the worst of conditions
- Recovers and Evacuates through both the high and low side service hoses
- Separate Vacuum pump for faster evacuations
- Additional service hose lengths available, 8 foot comes standard
- Programmed electrical outlet for optional heater blanket installation
- Charges on both High and Low side
- The FA1234 can easily be converted back and forth between four different refrigerants: R-134a, R-1234yf, R-22 and R-407C

To help you get a good start, please continue to carefully read the balance of this manual. This manual contains important information on the proper procedures for operating this equipment. Please pay close attention to the safety information, Warnings, and Cautions provided throughout this manual. Always remember "Safety First".

GENERAL SAFETY INSTRUCTIONS

Only qualified service personnel should operate this unit. Most states, countries, etc... may require the user to be licensed. Please check with your local government agency.

DANGER- this unit's recovery tanks contains liquid refrigerant. Overfilling of a recovery tank may cause a violent explosion resulting in severe injury or even death. Do not disable the overfill safety features. Always make sure the correct tank is on the scale.

DANGER- Only use the recovery tanks provided with this unit. See distributor for replacement tanks.

DANGER- Avoid breathing refrigerant vapors and lubricant vapor or mist. Breathing high concentration levels may cause heart arrhythmia, loss of consciousness, or even cause suffocation.

DANGER- Electrical shock hazard!!!! Always disconnect power source when servicing this equipment.

DANGER- DO NOT USE COMPRESSED AIR TO PRESSURE TEST OR LEAK TEST THE UNIT OR VEHICLE AIR CONDITIONING SYSTEM. Some mixtures of air and R-134a refrigerant are combustibile at elevated pressures. These mixtures are potentially dangerous and may result in fire or explosion causing personal injury or property damage.

CAUTION- all hoses may contain liquid refrigerant under pressure. Contact with refrigerant may cause frostbite or other related injuries. Wear proper personal protective equipment such as safety goggles and gloves. When disconnecting any hose, please use extreme caution.

CAUTION- avoid breathing refrigerant vapors and/or lubricant mist. Exposure may irritate eyes, nose, throat, and skin. Please read the manufacturers Material Safety Data Sheet for further safety information on refrigerants and lubricants.

CAUTION- do not use this equipment in the vicinity of spilled or open containers of gasoline or other flammable substances. Make certain that all safety devices are functioning properly before operating the equipment.

CAUTION- to reduce the risk of fire, avoid the use of extension cords thinner than NO. 16 awg. (1,5mm²). The following table references extension cord wire size vs. maximum length:

WIRE GAUGE	MAXIMUM LENGTH (feet)
16	10
14	25
12	50

CAUTION- do not use this equipment in the vicinity of spilled or open containers of gasoline or other flammable substances. Make certain that all safety devices are functioning properly before operating the equipment.

CAUTION- This equipment should be used in locations with mechanical ventilation that provides as least 4 air changes per hour.

CAUTION- RISK OF INJURY, the equipment should only be operated by certified personnel.

CAUTION- Use only CPS certified hose assemblies on this unit. The hose assemblies are made to proper length, contain shut offs where required and have direct affect on the proper operation of this equipment.

CAUTION- R-1234yf is a Class A2L flammable refrigerant. Use in well ventilated areas. Minimize leakage from the unit. Periodically check unit for leaks.

INITIAL EQUIPMENT PREPARATION

Models: FA1234, FA1234A and FA1234K

Will come with a 50 lb DOT tank and filter assembly pre-mounted on the rear of the machine. Please follow the instructions for initial equipment preparation:

1. Carefully unpack the unit and its contents from its shipping pallet.
2. Remove the Styrofoam insert from below the tank and cut the shipping band from around the tank.
3. Ensure all hose connections are firmly hand tight as they may have come loose during shipping.

The contents of the accessory box are as follows:

- 1 Power cord
- 1 R-134a refill hose
- 1 Set of R-1234yf hose holder fittings and caps
- 1 R-1234yf refill hose
- 1 1 lb check weight
- 1 R-1234yf ID tank label
- 1 R-134a ID tank label

For the FA1234E these additional items will be included in the accessory box.

- 1 Filter, filter bracket, Velcro and tie straps
- 1 Yellow liquid tank to filter hose

For models FA1234, FA1234A and FA1234K go to page 6. The following are instructions to mount the filter assembly and filter hose onto a self provided recover tank for model FA1234E. Place the tank on the center of the scale (Make sure the tank is free standing).

1. Install the filter bracket on the recovery tank as shown in Figure - 2a. Secure the filter bracket to the tank collar using the supplied tie straps. Cut off the excess tie strap after fully tightening.
2. Secure the filter to the bracket using the supplied Velcro straps making sure the arrow on the filter is pointing to the left as illustrated in Figure - 2b.
3. Install the refrigerant tank and filter hoses as shown in Figure - 2c. Connect the yellow liquid feed hose/hybrid adapter which comes from the machine to the filter port (a). Connect the yellow tank liquid hose from the tank liquid port (d) to the filter port (b). Connect the blue discharge hose coming from the machine to the vapor port (c) on the tank. Finally connect the ground wire to the tank as shown in Figure - 2c. If there is not a brass fitting on your particular tank, any unpainted surface on the tank itself will do.

FIGURE - 1 Shipping bracket

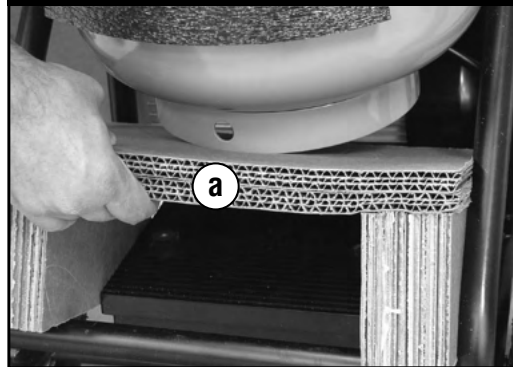

FIGURE - 2a Filter bracket placed on tank collar

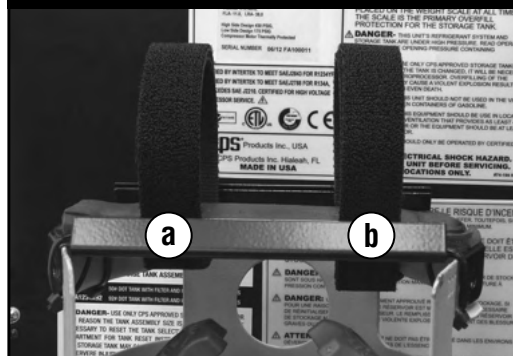

FIGURE - 2b Filter placed on filter bracket

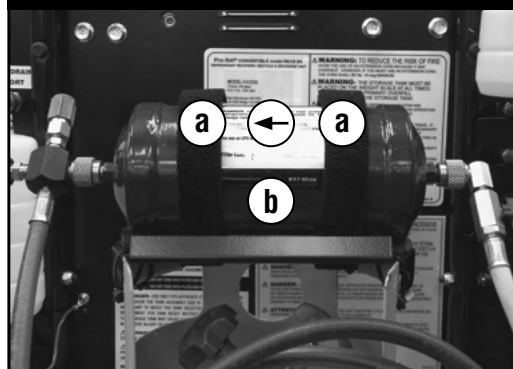
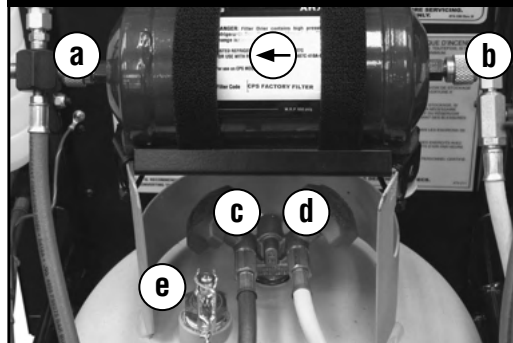

FIGURE - 2c Hose routing between filter, tank, and unit



FA1234 INITIAL SET-UP

The FA1234 is shipped from the factory in the R-134a SAE configuration. As indicated in our literature, the FA1234 can be set up for multiple refrigerants. The following instructions will guide you through the initial set up fo the unit that allows changes to operational software, language, units of measure and refrigerant.

Before we power up the unit, it will be necessary to check the vacuum pump oil sight glass for the correct level. The vacuum pump is pre-filled at the factory. Make sure the vacuum pump power switch is in the ON position. Also check the hose connecting to the vacuum pump is tight.

Open all tank and hose valves on the back of the unit.

Plug the unit into the proper voltage power supply. Check the nameplate of the unit if there are any questions on power supply requirements.

While holding down the **Key #3**, push the momentary ON-OFF switch on the back of the unit until the LCD lights up.

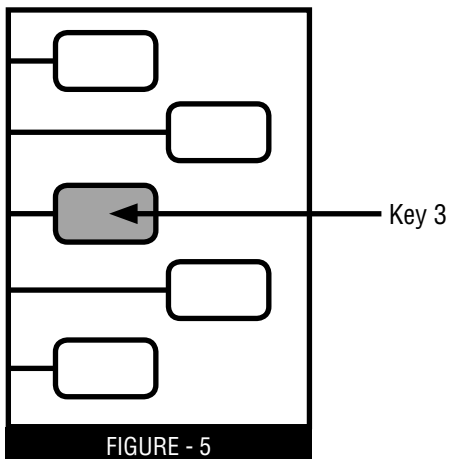

The LCD comes up with **SETUP MODE** screen asking for SAE or NON-USA.

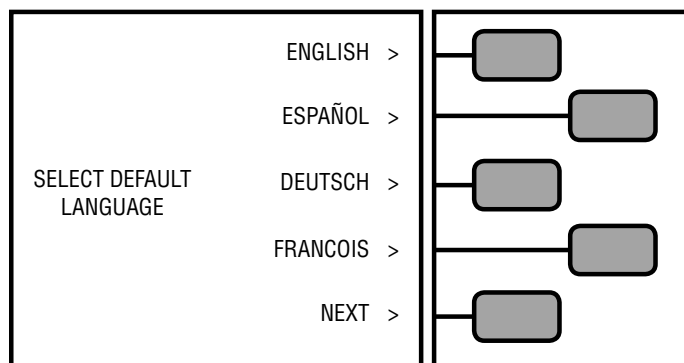

Push the key next to the desired language. The LCD will now show **SELECT DEFAULT UNITS OF WEIGHT**. Push the weight measurement system you are most likely to use. **Note: That during any Charge or Full Cycle operation, the UNIT OF WEIGHT can be temporarily changed.**

The unit will proceed to the automatic PT (Pressure Transducer) calibration and then (if required) the air purge. This should only take a few minutes and once complete the **Main Menu** will appear on the LCD.

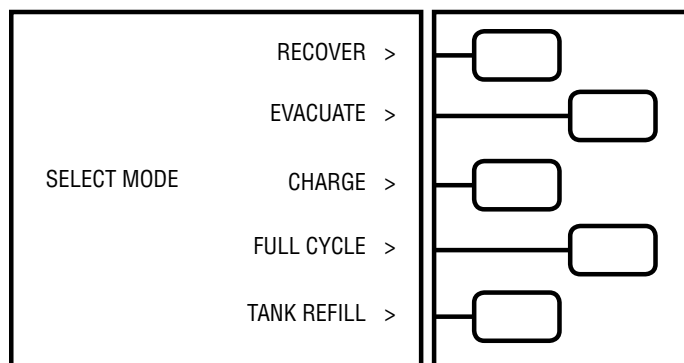
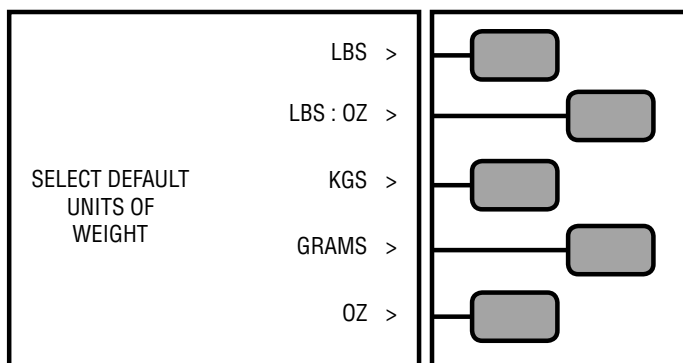

FA1234 is now ready for R-134a operation.

If the unit is being setup for a different refrigerant than R-134a, go to FA1234 Change Initial Refrigerant setting on pages 7-8.

If the unit will be used for R-134a, place the R-134a ID tank label on the storage tank.

Then go to page 20 to fill the recovery tank with R-134a.

FA1234 CHANGE INITIAL REFRIGERANT SETTINGS

The following instructions are to be used to change the initial default refrigerant from R-134a to either R-1234yf, R-22, or R-407C. To change the refrigerant after the unit has already been put into service, see Maintenance Section on page 25.

If the unit is ON, turn it OFF. Then while holding down the **Key #2**, push the momentary ON-OFF switch on the back of the unit until the LCD lights up. The LCD will come up in the Maintenance Mode. Push the **CHANGE REF** key.

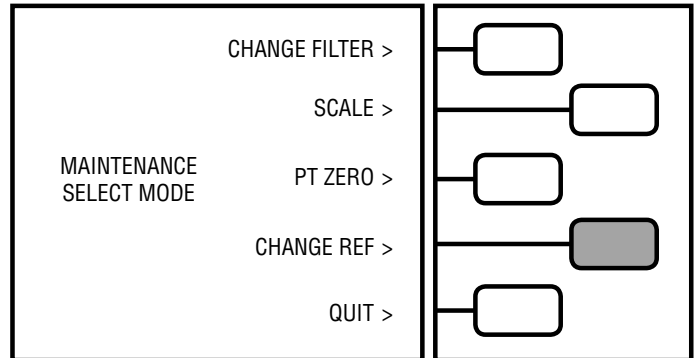
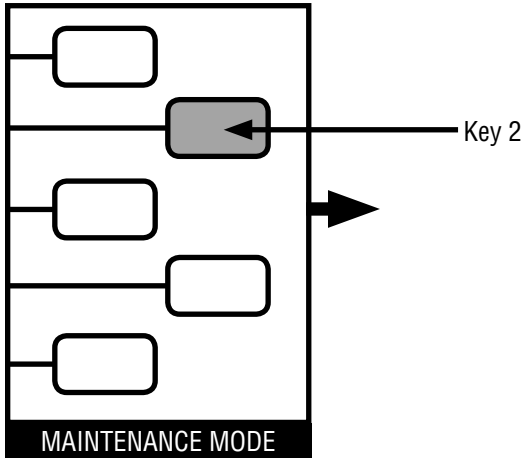

The LCD will have a list of refrigerants. Push the Key next to the refrigerant selection.

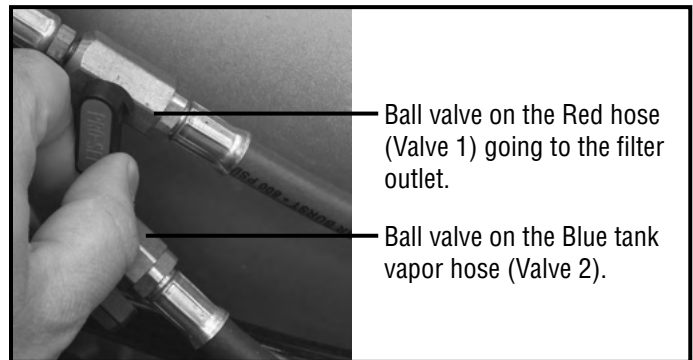
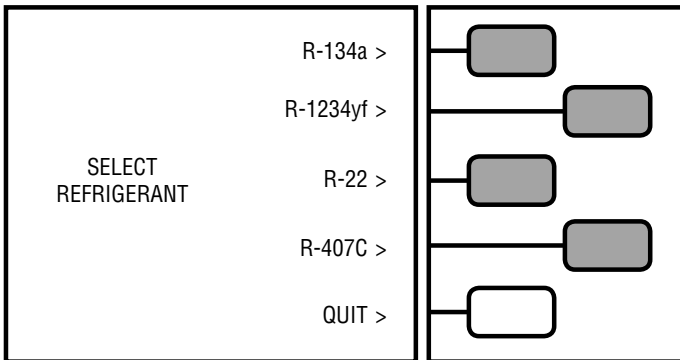

The LCD will show a message to CLOSE VALVE 1. Then push the CONTINUE key. The compressor will run for about 1 minute. HI and LO gauges will pull into a slight vacuum.

The LCD will show a message to CLOSE VALVE 2. Then push the CONTINUE key. The vacuum pump will run for about 3-5 minutes. HI and LO gauges will pull into a deep vacuum. Once done the LCD will read CHANGE TANK & HOSE.

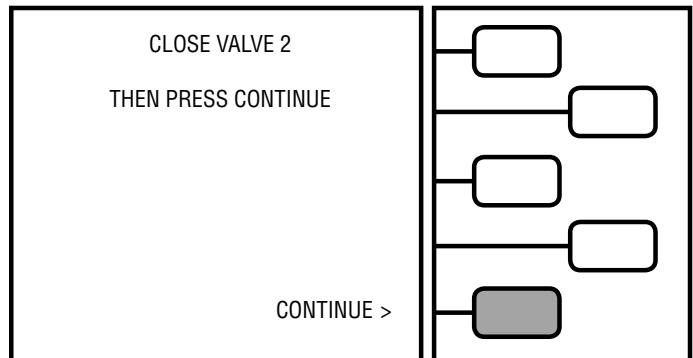
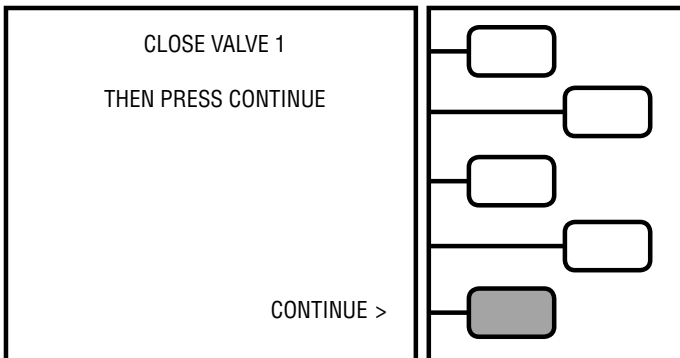

FA1234 CHANGE INITIAL REFRIGERANT SETTINGS

Since this is the initial setup, the tank/filter assembly is empty and does not need to be changed. If the refrigerant selection is R-1234yf, place the R-1234yf ID label on the tank. If R-22 or R-407C, use a permanent marker to identify the tank.

Remove the service hose cover. Install the correct service hoses for the refrigerant selected.

- The unit comes with the R-1234yf service hoses.
- For R-22 or R-407C refrigerant selection, purchase CPS hoses (HP8RE and HP8BE).

Once done, re-install the service hose cover.



The following are additional tasks to complete the R-1234yf conversion:

1. Close all tank and hose valves to prevent loss of vacuum. Replace the R-134a service nipples on the hybrid vehicle flush block hose assembly with the provided R-1234yf service nipples. The hybrid vehicle flush block is integrated into the hose that connects from the back of the unit to the filter out connection. Once done, open all tank and hose valves.
2. Replace the R-134a storage nipples on the unit's handle with the provided R-1234yf storage nipples.

Push the **CONTINUE** key. The unit will proceed to do the automatic PT (Pressure Transducer) calibration and then (if required) the air purge. This should only take a few minutes and once complete the **Main Menu** will appear on the LCD.

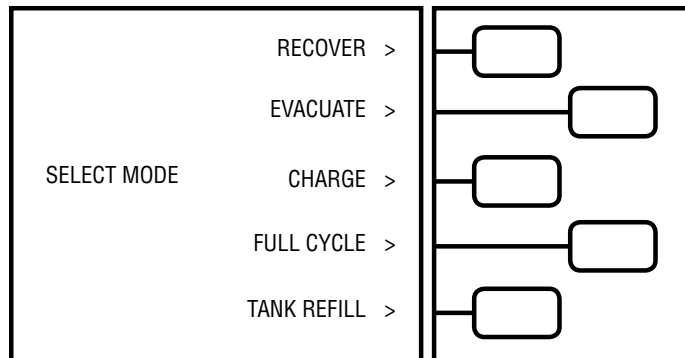
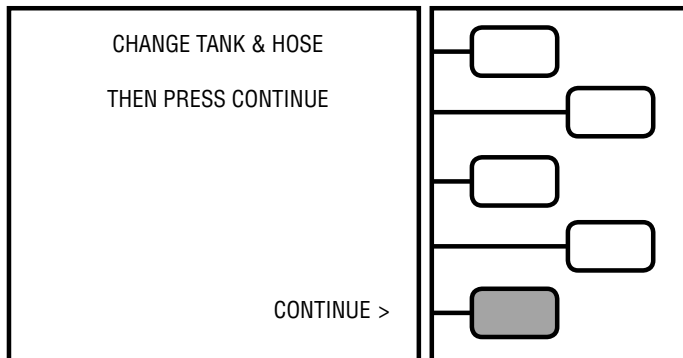

It will be necessary to fill the storage tank with the assigned refrigerant in order to run recharge an AC system. The unit can perform recovery operations at this time, but cannot charge. Go to the TANK REFILL mode instructions on page 20 to add refrigerant to the tank.

Initial setup is now complete. Read the balance of this manual for complete operating and maintenance instructions.

OPERATING INSTRUCTIONS FOR THE FA1234

IMPORTANT: BEFORE USING THIS START UP GUIDE IT IS HIGHLY RECOMMENDED THAT THE USER COMPLETELY READ AND UNDERSTAND THIS ENTIRE MANUAL. FAILURE TO OPERATE AS SPECIFIED COULD RESULT IN DAMAGE TO THE UNIT, WHICH COULD ALSO LEAD TO LOSS OF WARRANTY.

The FA1234 is a microprocessor driven unit. The operating instructions are contained on the LCD. Simply choose the desired function of the unit and follow the directions on the LCD. The following are the basic instructions on safely operating each function of this unit.

Operating Instructions

Open all Storage Tank Valves. Push the momentary Power switch to (ON). The unit will run a brief diagnostic routine. LCD will read: **RE-Zeroing PT, Please wait**. Once done with PT calibration process, the unit will proceed to the automatic air purge sequence. This will take up to 3 minutes.

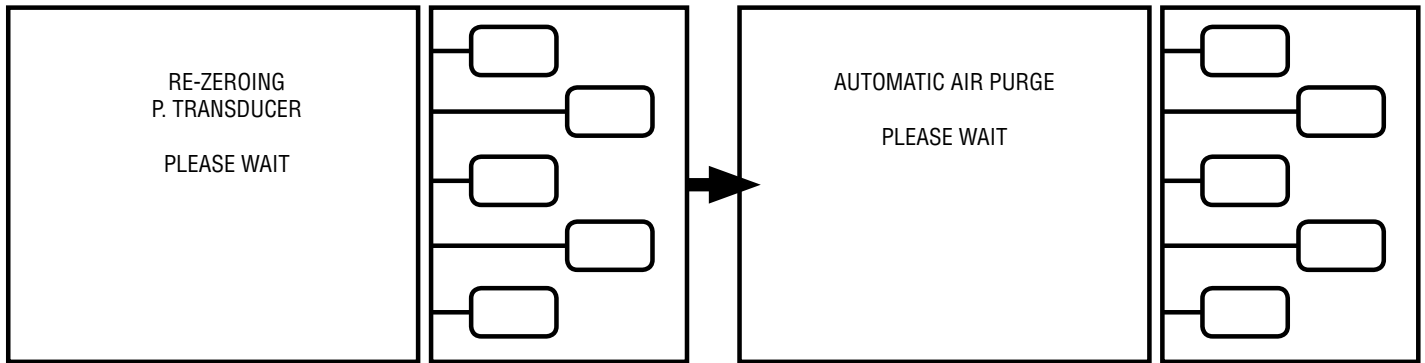

The LCD screen should now read: This is called the **MAIN MENU**.

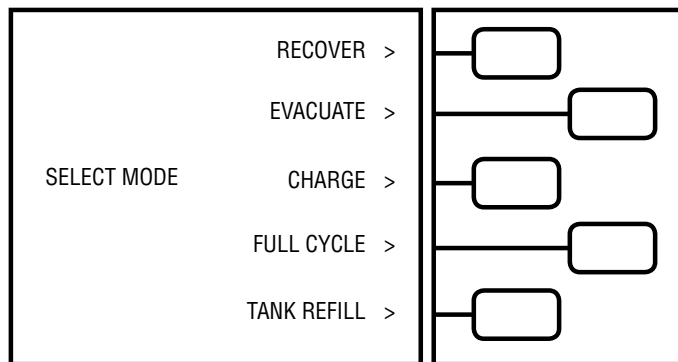

- Connect the refrigerant service hoses to the automobile A/C system to be serviced.
- Open the High and Low side service couplers.

Push the **KEY** for the desired mode.

The different modes are as follows:

1. Recover
2. Evacuation (Vacuum)
3. Charge
4. Full cycle
5. Tank refill

Follow the directions on the LCD for each mode. The following pages will discuss the operation of each mode in detail.

OPERATING INSTRUCTIONS FOR THE FA1234

RECOVER / RECYCLE MODE: The Recover/Recycle mode would be chosen to recovery refrigerant from an Auto A/C system that needs a refrigerant containing component replaced such as a compressor, evaporator, orifice tube, condenser, etc....

IMPORTANT: Before starting the recover of the refrigerant, a refrigerant identifier should be used to determine the type and purity of the refrigerant. Failure to properly identify the refrigerant could potentially expose the user to danger from flammable refrigerants and health hazards from toxic refrigerants. Cross contamination of refrigerants can also occur and would require special handling of the refrigerant.

From the Main Menu screen,
Push the **RECOVER** key.

The LCD will now read:
Push the **START** key.

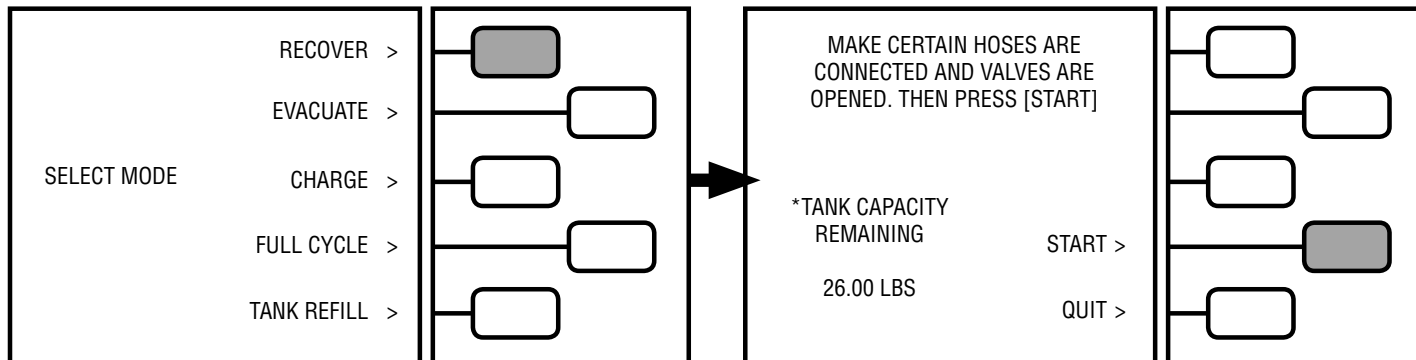

The LCD will now read:
The FA1234 is now recovering refrigerant.
The LCD will show the amount of refrigerant recovered.

When the FA1234 reaches approximately 20" hg. vacuum.
The LCD will now read:
The FA1234 will proceed to drain the recovered oil:

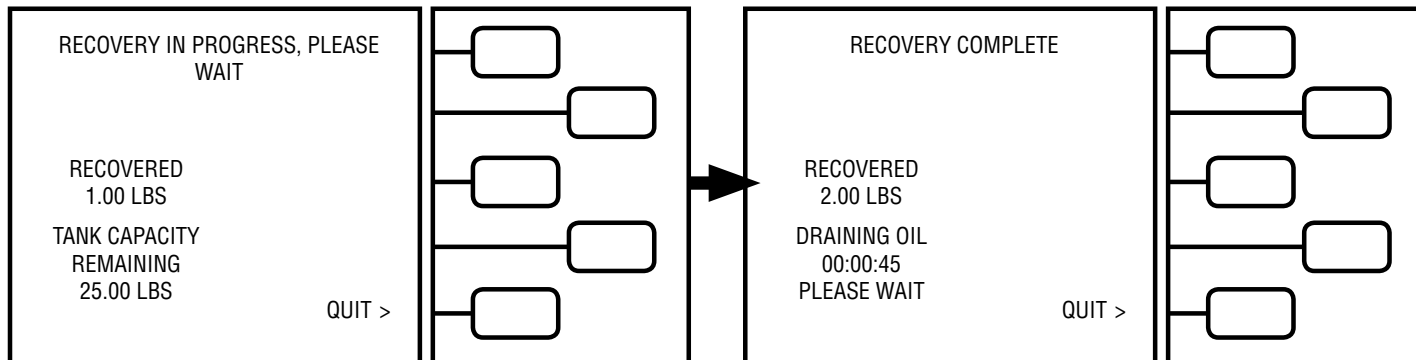

Record the **RECOVERED** weight reading on the LCD. Push the **QUIT** key to return to **Main Menu** (as shown below) or **PROCEED TO EVACUATE** key for evacuation operation. Do not forget to measure the A/C oil in the oil drain bottle for future A/C oil re-injection. **RECOVER/RECYCLE** Operation is now complete.

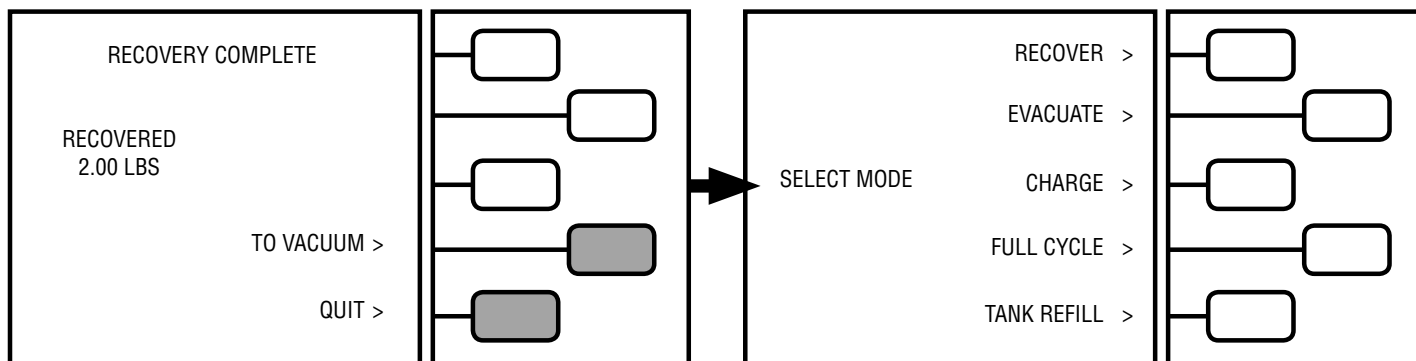

* TANK CAPACITY REMAINING - is the amount of space available in storage tank.

OPERATING INSTRUCTIONS FOR THE FA1234

EVACUATE MODE: The EVACUATE Mode would be chosen to remove air and moisture from an Automobile A/C system that has been open to the atmosphere. **CAUTION: Air and moisture in an A/C system can cause premature failure of A/C system components.**

From the Main Menu screen,
Push the **EVACUATE** Key

The LCD will now read:
Push the + or – ARROW keys until the desired vacuum time is programmed. Once done, push the **START** key.

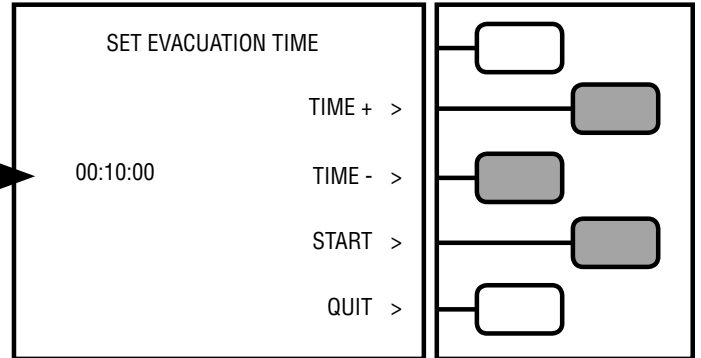
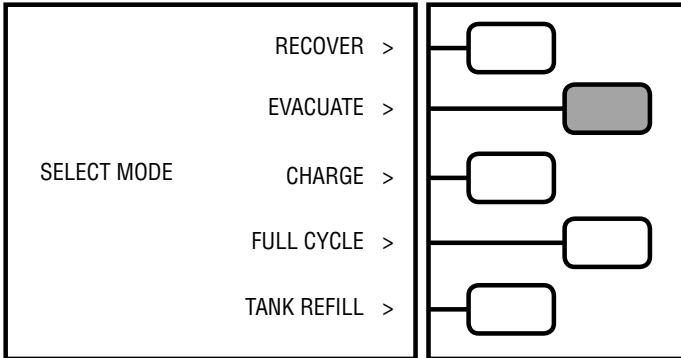

The LCD will now read:
The vacuum pump will run until the **TIME REMAINING** reaches 00:00

The unit will then proceed to a 2:00 minute leak check test.
The LCD will now read:

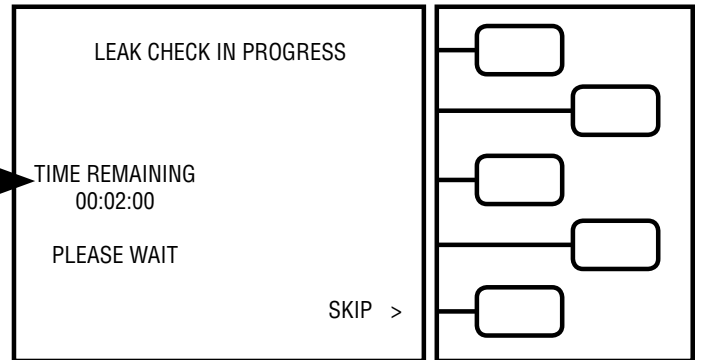
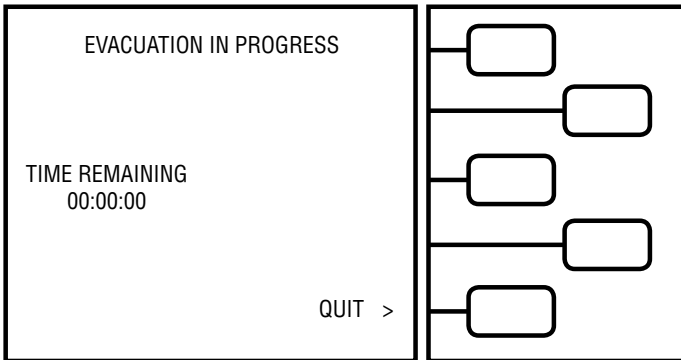

If leak check fails, check A/C system for leaks.
If leak check passes
The LCD will now read:

Push the **QUIT** key to return to Main Menu or **CHARGE** key for charge operation.

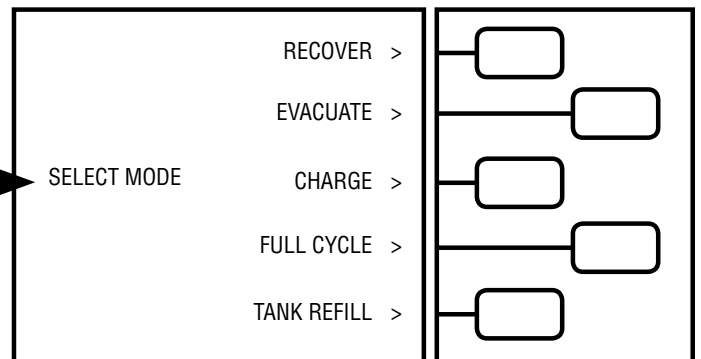
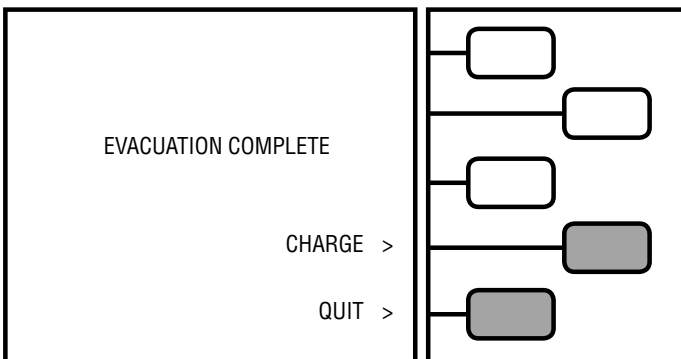

NOTE: If a leak is detected, the LCD will be prompted.

OPERATING INSTRUCTIONS FOR THE FA1234

CHARGE MODE: The CHARGE mode would be chosen to recharge a mobile A/C system after it has been properly evacuated. This is also the time to inject oil back into the A/C system. **See special instructions on page 26 for High Voltage Compressor A/C system charging.**

From the Main Menu screen,
Push the **CHARGE** key.

The LCD will now read:
Select which service hose unit should charge through. It is recommended to use **HIGH SIDE** charging to prevent compressor slugging.

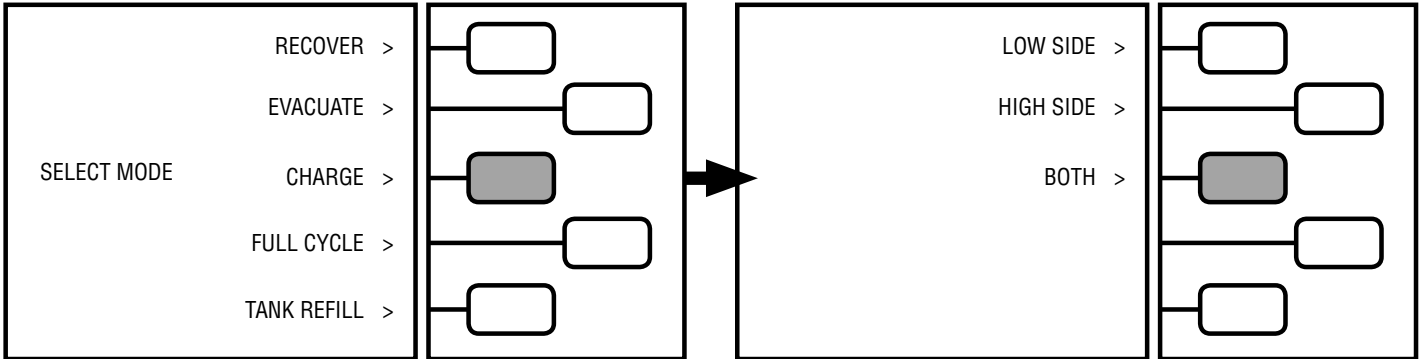

The LCD will now read:
If desired, the units of measure can be changed at this time. Push the **CHANGE UNITS** key.

If the **CHANGE UNITS** key is pushed, the LCD will read:
Select units of measure.

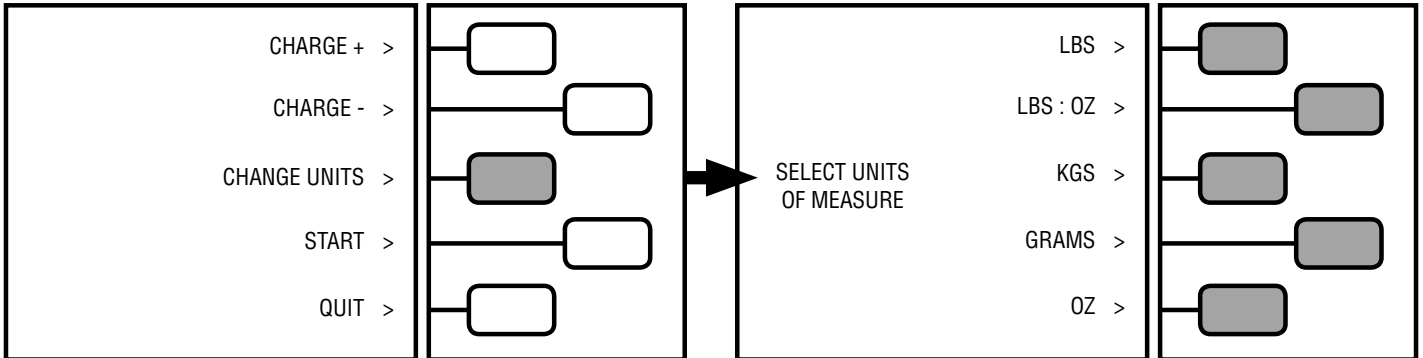

Continue by pushing the + or - ARROW key until the charge amount is programmed. Once desired amount is programmed, push the **START** key.

The LCD will now read:
Open the oil injection valve until the desired amount is dispensed. Push **CONTINUE** key once oil injection is complete.

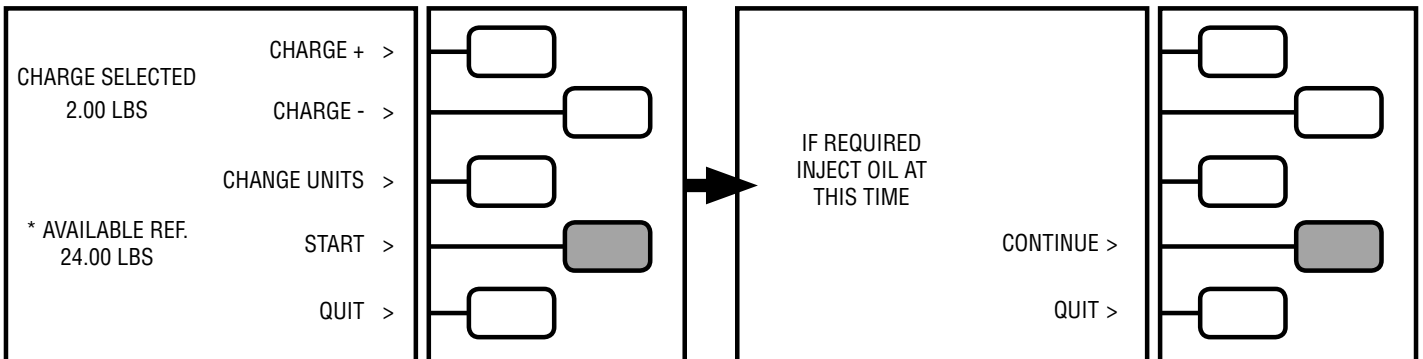

* AVAILABLE REF. This is the amount of refrigerant available for charging. If this drops below zero, charging will not start.

OPERATING INSTRUCTIONS FOR THE FA1234

The LCD will now read:
The **CHARGE DISPENSED** reading will begin to increase.

Note: If the unit does not completely dispense the charge into the A/C system, the LCD will notify the user of options to complete the charge.

Once the CHARGE DISPENSED equals the CHARGE.
The LCD will read: Close HIGH SIDE COUPLER.
Push **CONTINUE** key

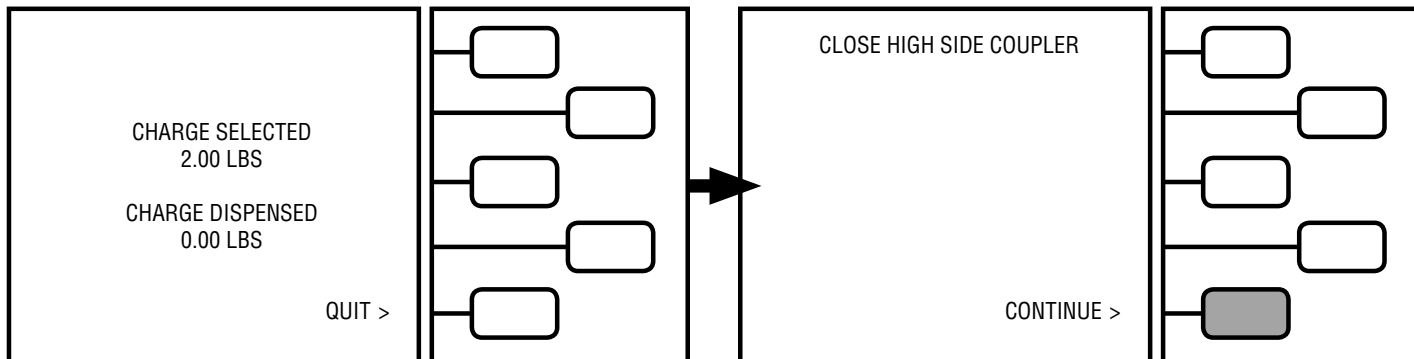

Start car A/C system, Push **CONTINUE** key.

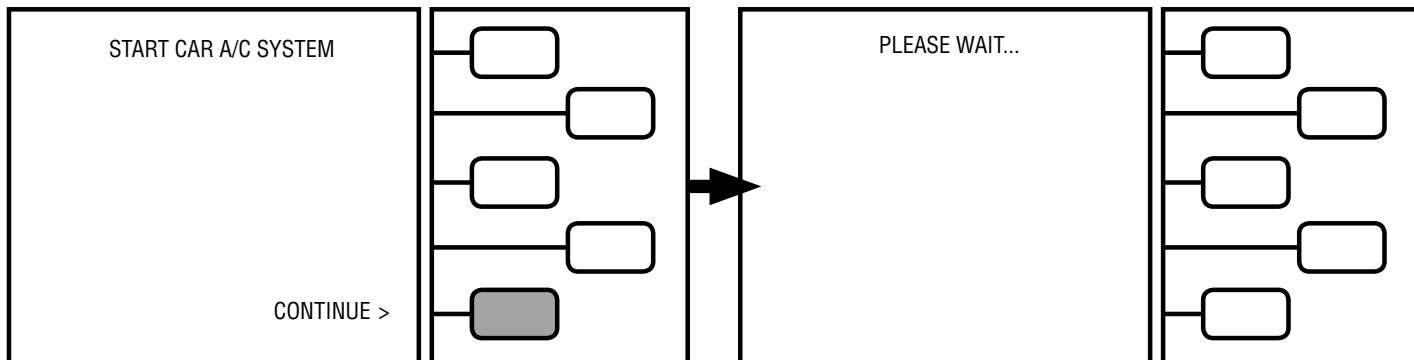

Charge is now complete. Push **QUIT** key to return to MAIN MENU

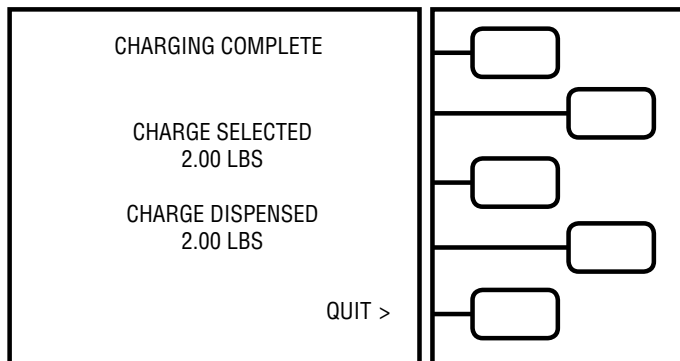

OPERATING INSTRUCTIONS FOR THE FA1234

FULL CYCLE: The fully automatic mode is commonly used at quick car care service facilities where no leaks or repairs are required, but the A/C system seems to be undercharged.

IMPORTANT: Before starting the recover of the refrigerant, a refrigerant identifier should be used to determine the type and purity of the refrigerant. Failure to properly identify the refrigerant could potentially expose the user to danger from flammable refrigerants and health hazards from toxic refrigerants. Cross contamination of refrigerants can also occur and would require special handling of the refrigerant.

From the **MAIN MENU** screen,
Push the **FULL CYCLE** key.

The LCD will now read:
Push the + or - ARROW keys until the desired vacuum
time is programmed. Push the **NEXT** key.

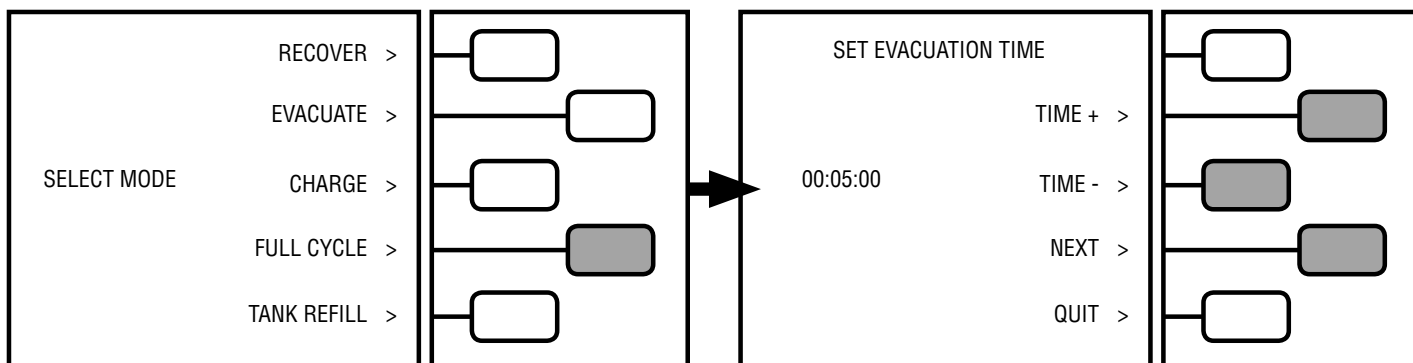

The LCD will now read:
If oil injection is required, push the **YES** key.
Otherwise push the **NO** key. If the YES key is pushed,
you will be notified when to inject the oil.

The LCD will now read:
If desired, the units of measure can be changed at this
time. Push the **CHANGE UNITS** key.

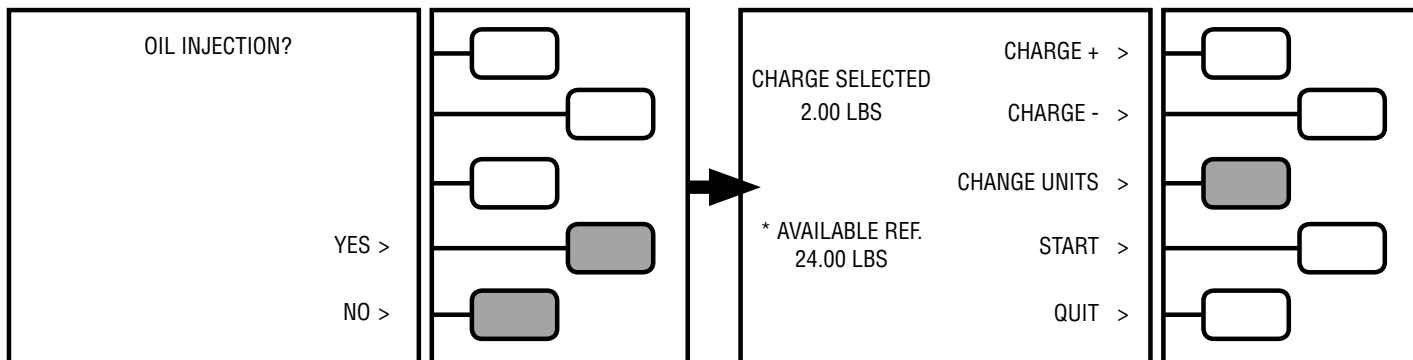

OPERATING INSTRUCTIONS FOR THE FA1234

If the **CHANGE UNITS** key is pushed, the LCD will read:
Select units of measure.

The LCD will now read:
Continue by pushing the + or - ARROW key until the charge amount is programmed. Once desired amount is programmed, push the **START** key

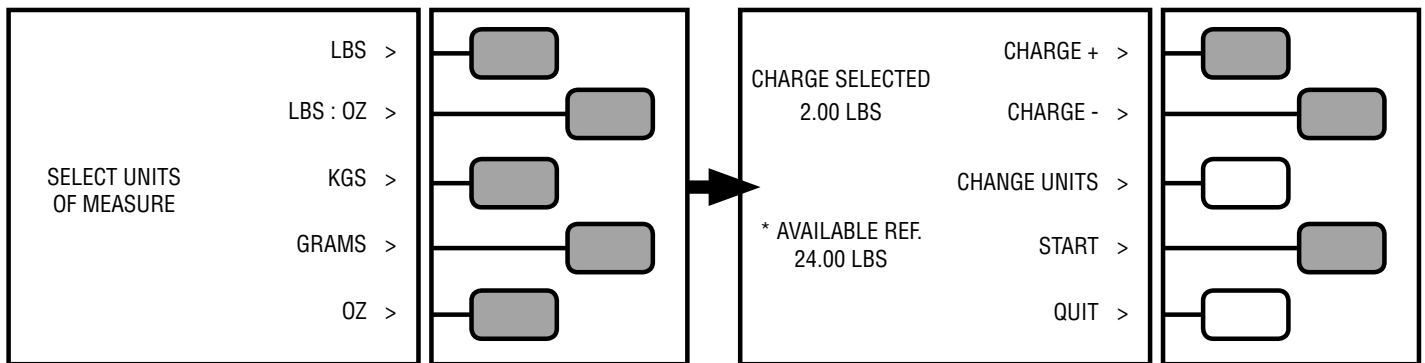

The LCD will now read:
The FA1234 is now recovering refrigerant.
The LCD will show the amount of refrigerant recovered.

When the FA1234 reaches the required vacuum level,
the unit will proceed to drain the recovered oil:
The LCD will now read:

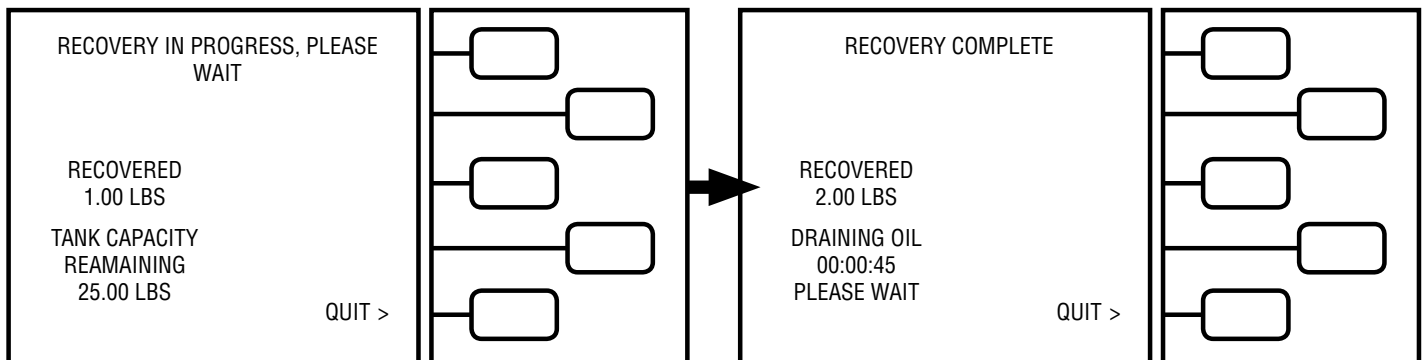

* AVAILABLE REF. This is the amount of refrigerant available for charging. If this drops below zero, charging will not start.

* TANK CAPACITY REMAINING - is the amount of space available in storage tank.

OPERATING INSTRUCTIONS FOR THE FA1234

Once **DRAINING OIL** is complete, the unit will proceed to **Evacuation**. The vacuum pump will run until the **TIME REMAINING** reaches **00:00**. The LCD will now read:

The unit will proceed to a 2:00 minute leak check test. The LCD will now read:
Note: If leak check fails, check A/C system for leaks. The FULL CYCLE process will be aborted.

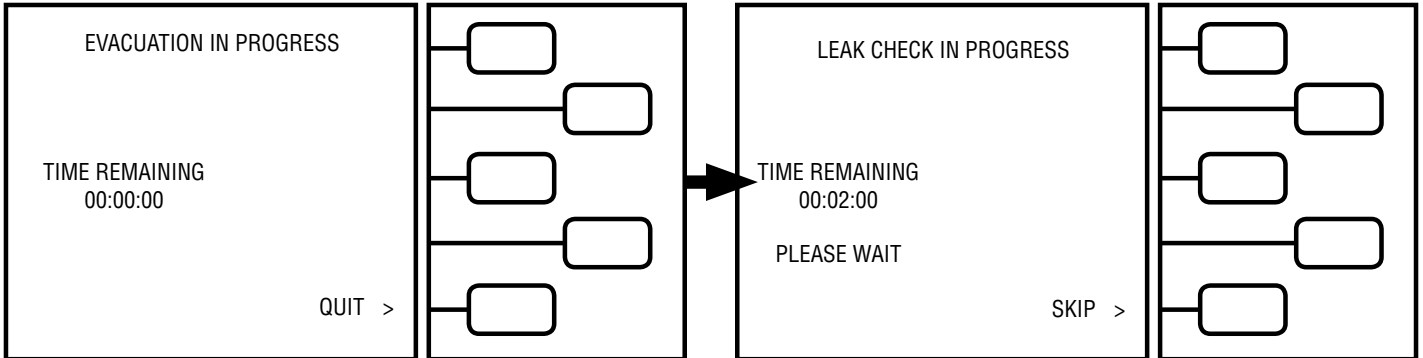

Once the **LEAK CHECK** has passed or the **SKIP** key is pushed, The LCD will read: Open the oil injection valve until the desired amount is dispensed. Push the **CONTINUE** key

The LCD will now read:
 The **CHARGE DISPENSED** reading will begin to increase.
Note: If the unit does not completely dispense the charge into the A/C system, the LCD will notify the user of options to complete the charge.

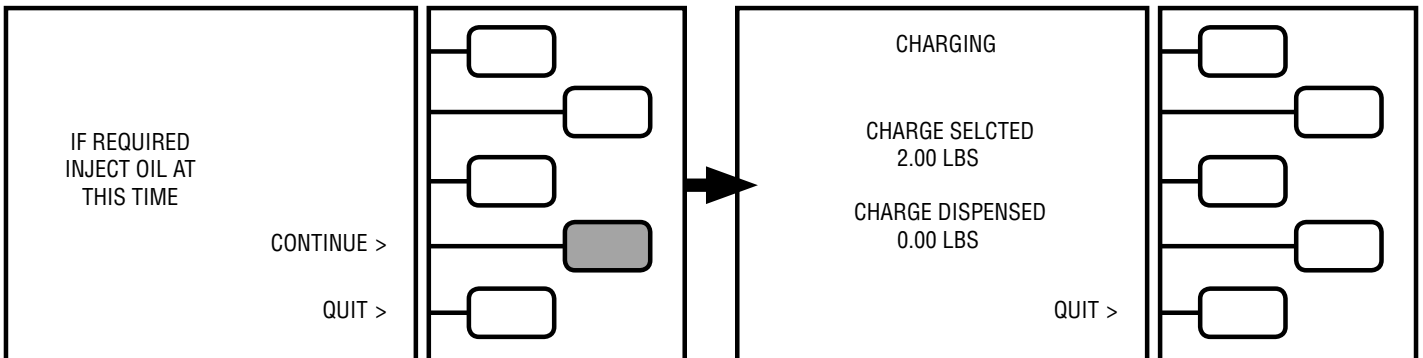

See Figure - A on page 12 for further details on the oil injection system.

Once the **CHARGE DISPENSED** equals the **CHARGE**. The LCD will read: Close **HIGH SIDE COUPLER**. Push **CONTINUE** key

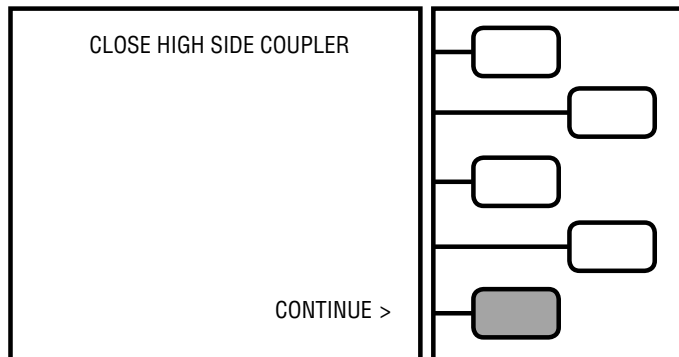

OPERATING INSTRUCTIONS FOR THE FA1234

Start car A/C system, Push **CONTINUE** key.

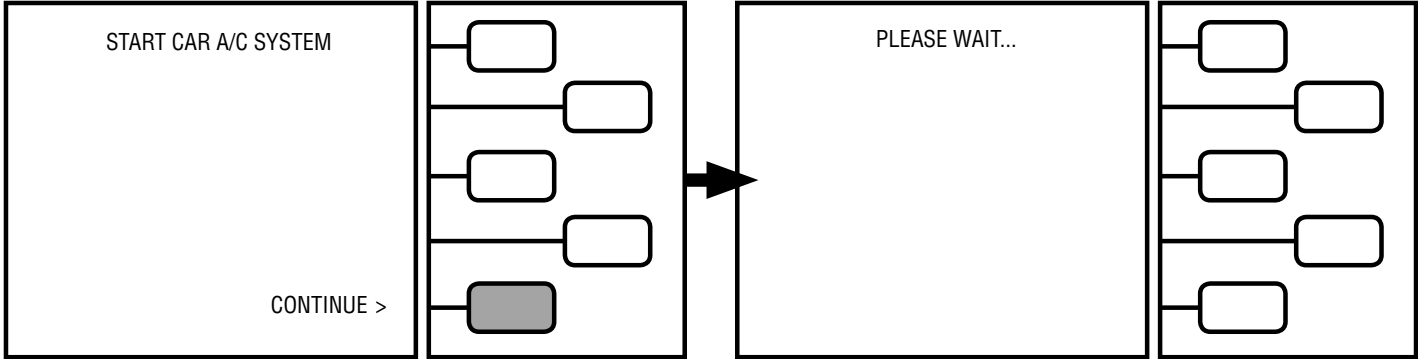

Once the charge amount has been met, The LCD will read:
Record the data on the LCD. Push the **QUIT** key.
FULL CYCLE is complete.

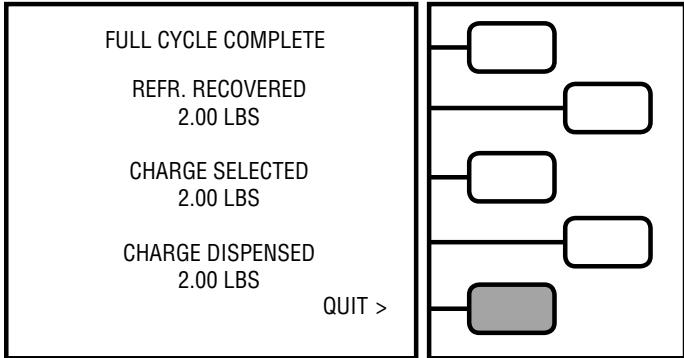

The LCD will return to the main menu.

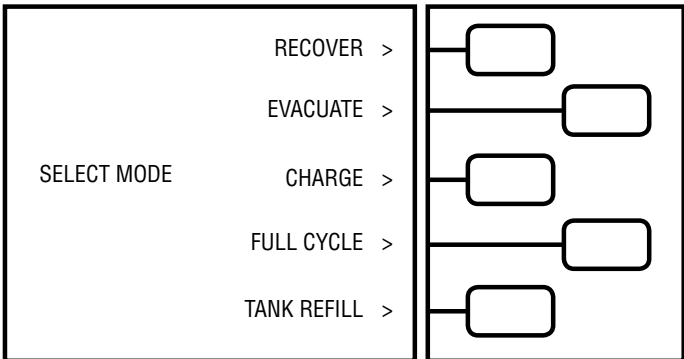

OPERATING INSTRUCTIONS FOR THE FA1234

REFILL MODE: The REFILL mode would be chosen to add refrigerant to the tank for the first time or add more refrigerant to the recovery tank. This operation can be run pushing the **TANK REFILL** key from the **Main Menu** or may be prompted when insufficient refrigerant exists when in **CHARGE** or **FULL CYCLE** modes. It's recommended to use a refrigerant identifier on the virgin supply tank to guard against counterfeit refrigerants.

From the **MAIN MENU**,
Push the **TANK REFILL** key.

The LCD will now read:
Connect the High Side service hose to a virgin supply tank.
Push the **START** key.

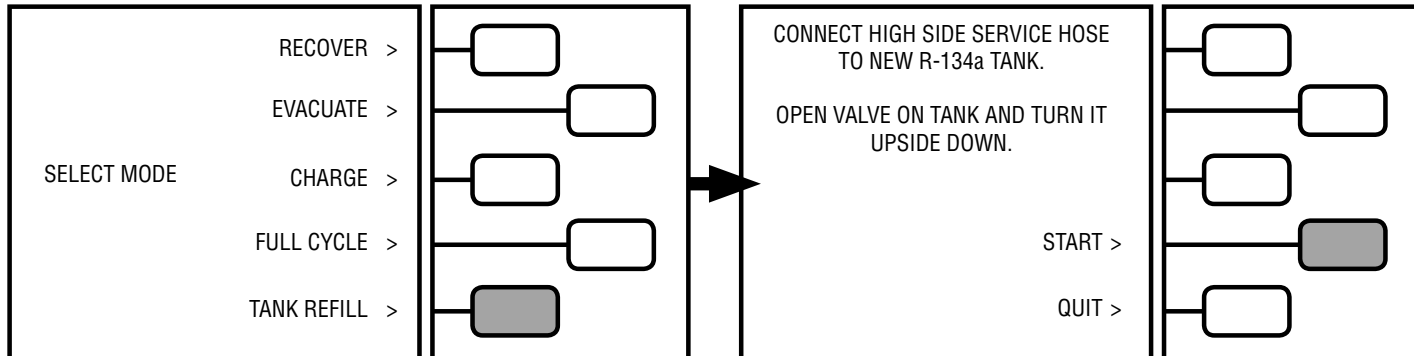

Note: To speed up the Refill process, turn the supply tank upside down or make sure the liquid refrigerant is being recovered.

The LCD will now read:

Caution: Do not turn off unit. If stoppage is required, close the HIGH SIDE COUPLER and all the unit to complete the clearing process.

If **REFILLING** amount reached zero, the LCD will read:
Push the **Quit** Key to return to Main Menu.

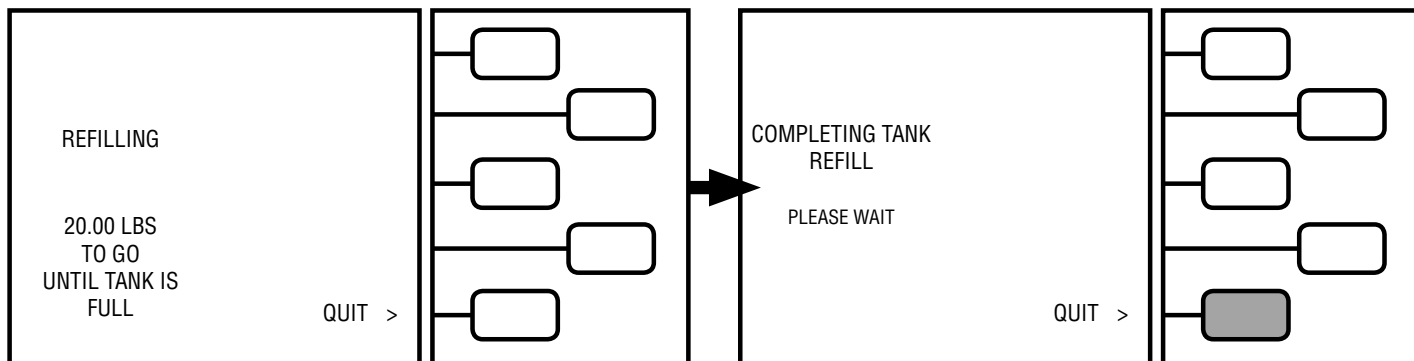

The unit will run until: 1. REFILLING amount on LCD reaches zero or 2. Virgin supply tank is pulled into a vacuum

If Virgin supply tank is pulled into a vacuum,
the LCD will read:

Either add a new Virgin supply tank and push **RESUME** or
Push the **QUIT** key to return to Main Menu.

Pushing the **QUIT** key will return to the main menu.

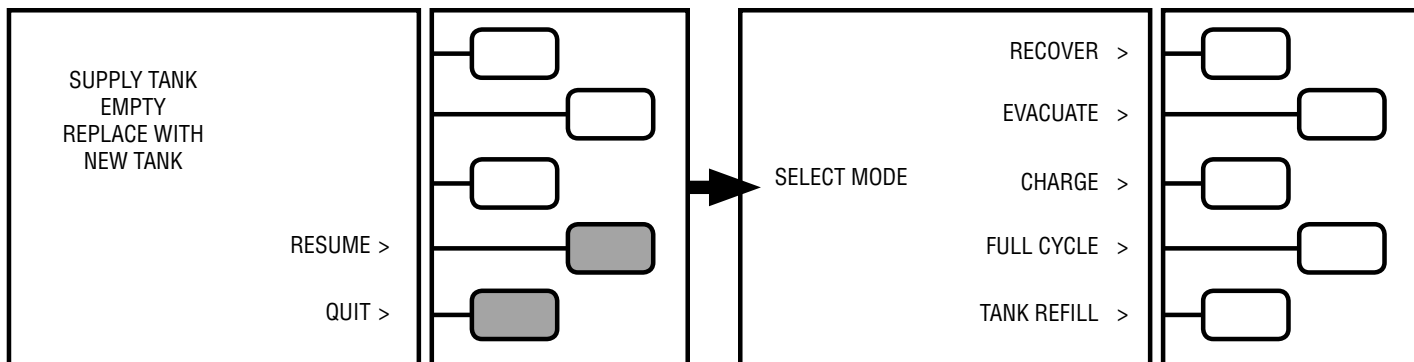

MAINTENANCE

MAINTENANCE MODES: DURING NORMAL OPERATION OF FA1234

FILTER CHANGE: The FA1234 uses a mass flow tracking system on how much recovered refrigerant has passed through the Filter Drier (CPS p/n ARXF5). Each 41 Cubic Inch Drier can handle 150 lbs. of refrigerant before requiring change. When it is determined that the filter has exceeded the 150 lbs., the unit will show messages on the status of the filter on the LCD. It is necessary to purchase a Filter Drier under CPS p/n ARXF5. Each new Filter Drier comes with a unique code to reset the filter to 100%. The FA1234 has a lower tilt drawer design to hold 2 spare filters.

When choosing the RECOVER or FULL CYCLE modes, the FA1234 will remind the user to order a filter when the FILTER LIFE REMAINING is below 25%. The following is an example of the LCD when Filter Life is less than 25%: Push the **CONTINUE** key to proceed to filter change.

When the Filter Life reaches 0%, the following LCD screen will come up. Push the CHANGE FILTER key to begin filter change procedure. **Note: pushing QUIT key at this time will return the unit to the Main Menu.**

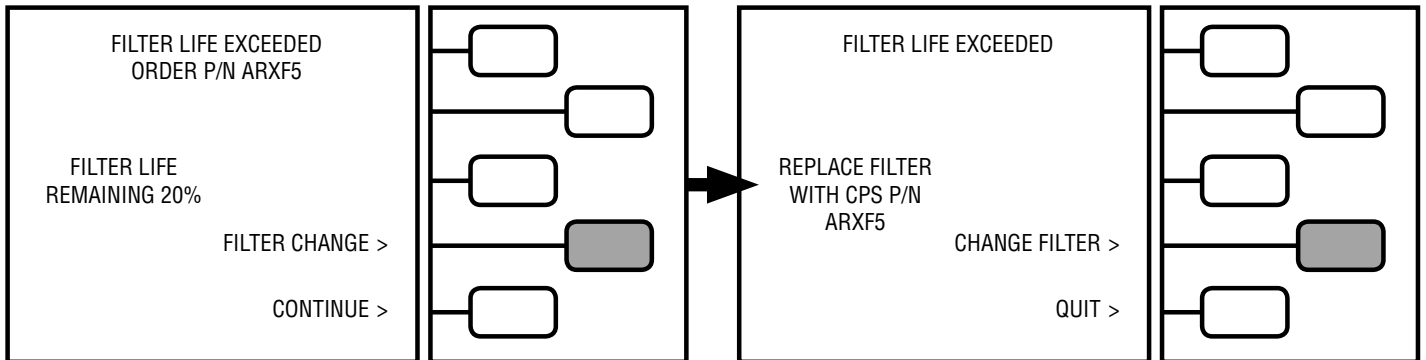

The LCD will now read:
Push the **START** key to begin Filter Change routine.

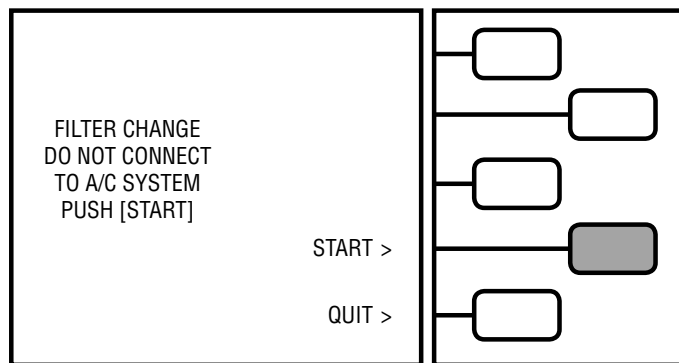

The LCD will now read:
After closing liquid port tank valve, push **CONTINUE** key

The LCD will now read:
The evacuation process will take about 2-5 minutes.
The unit will run until a filter has been evacuated.

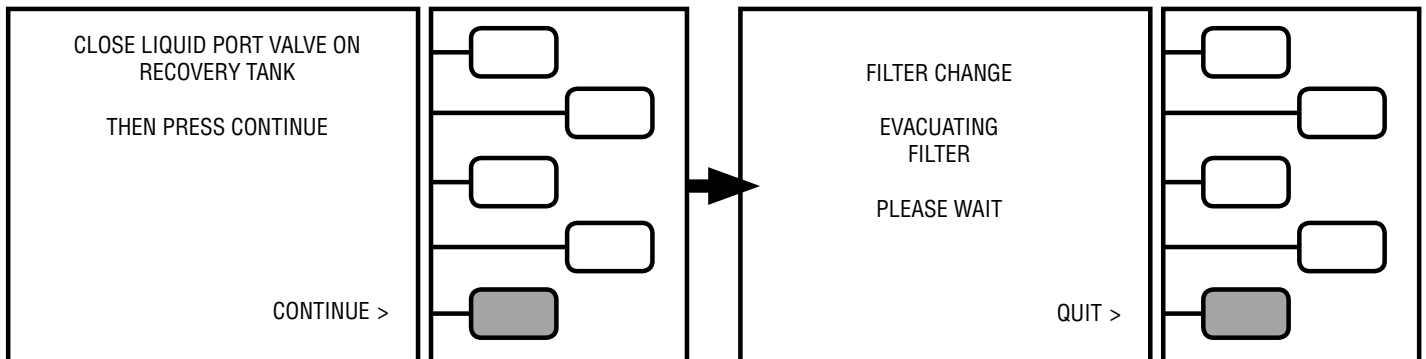

AUTOMATICALLY OCCURRING DURING THE OPERATION OF THE UNIT

FILTER CHANGE (continued):

Once the filter has been evacuated, the LCD will read:
 Replace the filter with new ARXF5.
 Then Push the **NEXT** key:

LCD will now read:

Use the +, -, KEYS to fill in the filter code for each blank.
 Use the <, > KEYS to move cursor to the next blank
 See filter label for code..

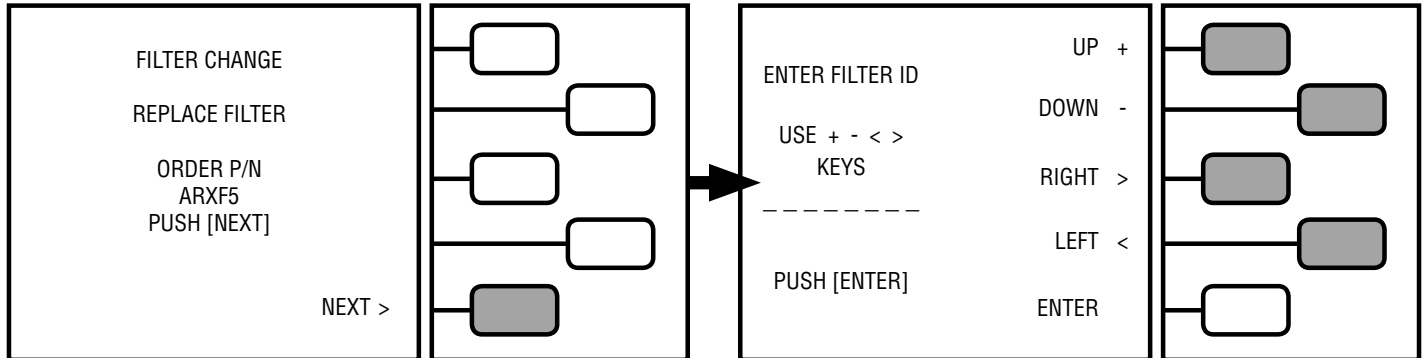

Push the **ENTER** key once the entire code is shown on LCD.

The LCD will now read:

Filter Change is now complete. Push the **QUIT** key to return to **MAIN MENU**.

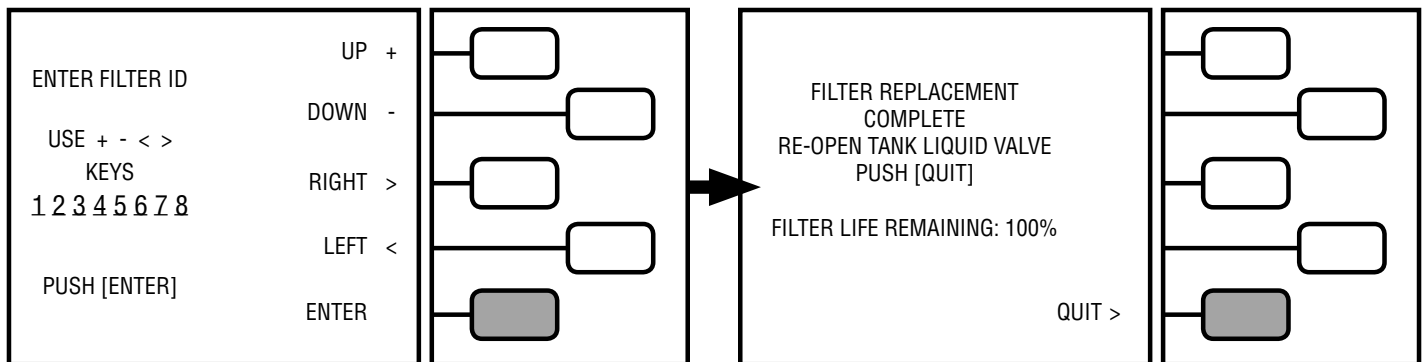

VACUUM OIL CHECK:

Every 10 hours of vacuum pump run time the following message will appear in **EVACUATION** or **FULL CYCLE** modes. The oil level can be seen through the sight glass of the vacuum pump. To change the oil, first loosen the wing nut under the frame and then slide the vacuum pump out. The vacuum pump oil should be clear, use CPS vacuum pump oil p/n VPOP, VPOQ, VPOG. Make sure the oil level is up to the fill mark on the oil sight glass. Push **CONTINUE** key to proceed to the **EVACUATION** or **FULL CYCLE** modes.

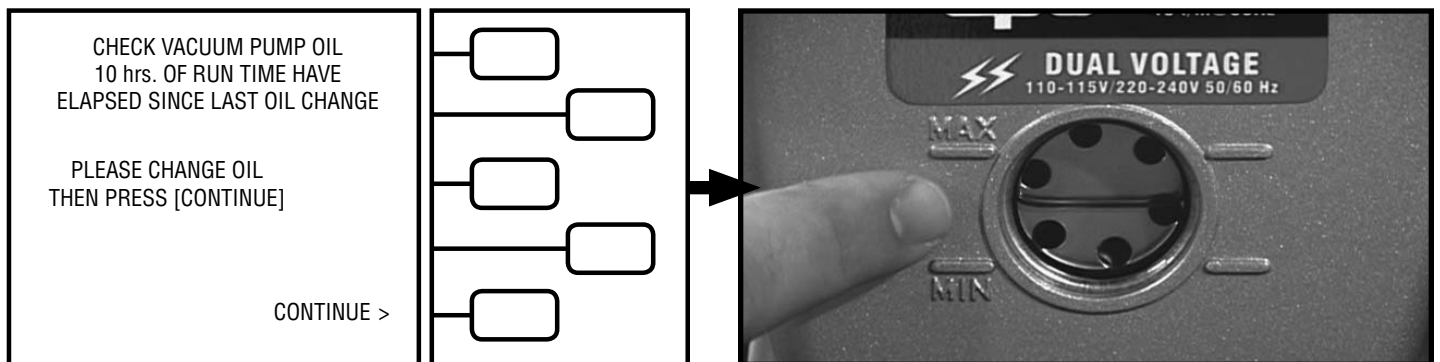

Automatic Non-condensable Gases (NCG) Purge: Upon start up of the unit, the NCG purge will begin automatically. If the compressor was recently run, it could take up to 30 minutes before the NCG routine is allowed to run. To perform this operation, simply turn the unit off and back on.

MAINTENANCE

MAINTENANCE VIA KEYPAD OPERATION

To enter into the units **MAINTENANCE** mode, hold down **Key 2** and then turn power switch on.

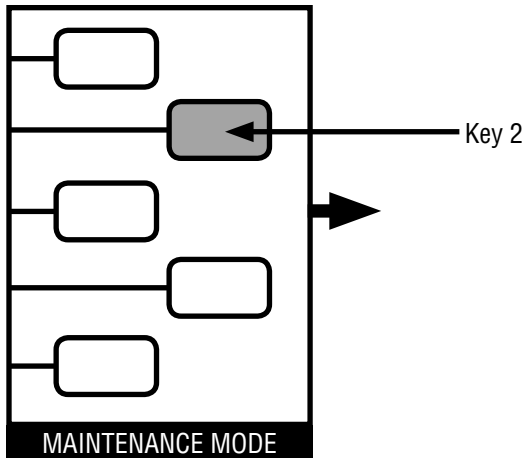

The LCD will now read:
FILTER CHANGE: Push the **CHANGE FILTER** key.
Go to page 21 for detailed FILTER CHANGE instructions.

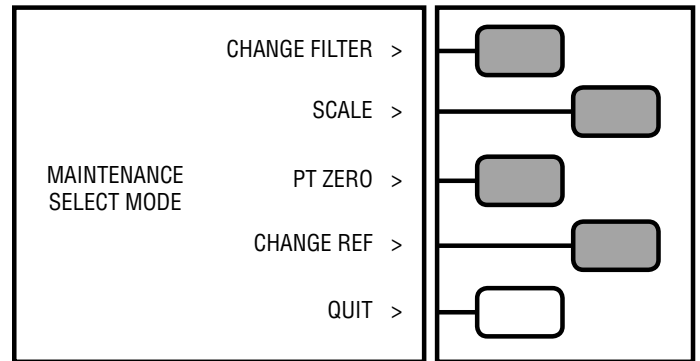

SCALE CHECK:

Push the **SCALE** key. The LCD will now read:
 Push the **YES** key to proceed with accuracy check.
 Pushing the **NO** key will skip the accuracy check and proceed to the **Re-Zeroing** function.

The LCD will now read:
 Place Calibration Weight on tank.
 Push the **YES** key if weight reading matches Calibration weight.
 (Push the **NO** key if weight does not match. See service manual for complete scale re-calibration procedure. A 25LB or 15KG Class F weight will be required for scale re-calibration.)

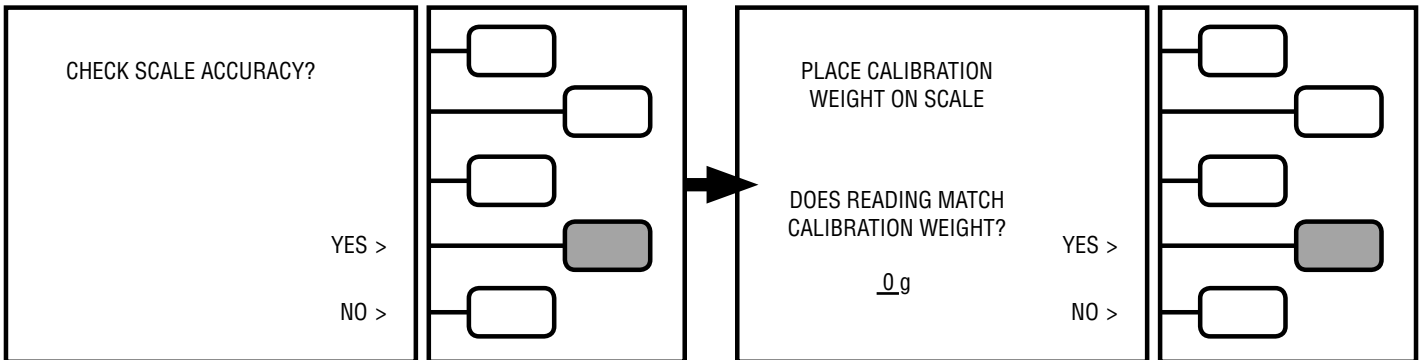

The LCD will now read:
 Push the **YES** key to proceed with **RE-ZERO** scale.
Note: Pushing the NO key will prompt the unit to reboot and Go to MAIN MENU

LCD will now read:
 Lift the Tank off the scale.
 Then Push **NEXT** key.

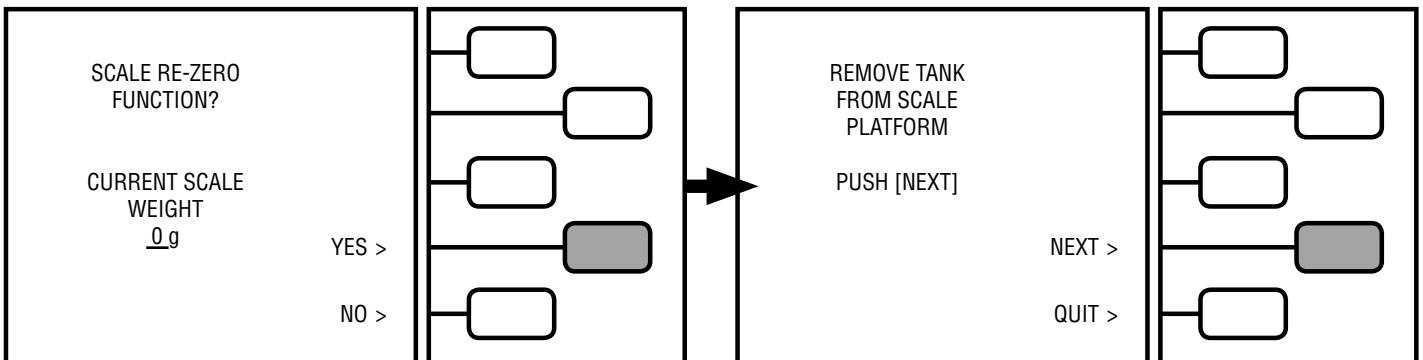

The LCD will now read:
Wait until the LCD screen changes.

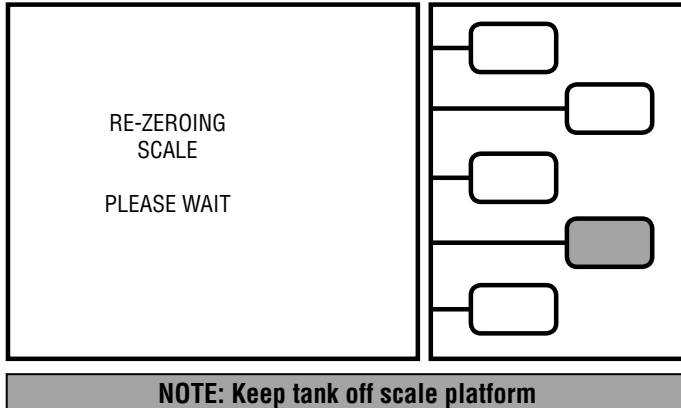

The LCD will now read:
Push the **YES** key if **CURRENT SCALE WEIGHT** is zero.
The unit will re-boot and go to the **MAIN MENU**.
Pushing the **NO** key will repeat Re-Zeroing process.

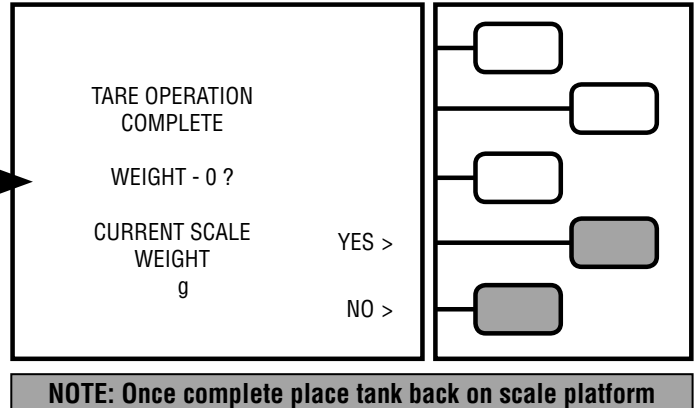

PT SENSOR/GAUGES:

Push the **PT SENSOR** key.
The FA1234 will begin a automatic routine to recalibrate the Pressure Transducer (PT)

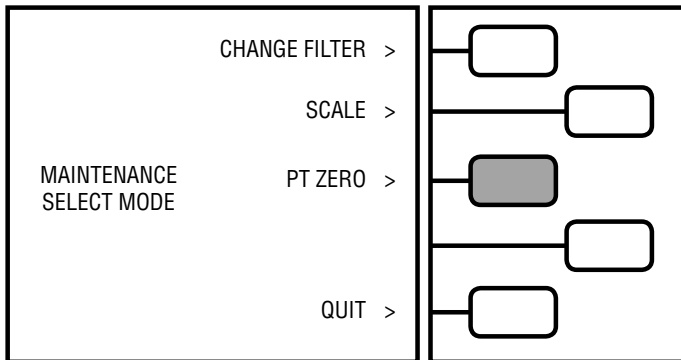

The LCD will now read:
Wait for Re-zeroing procedure to complete.

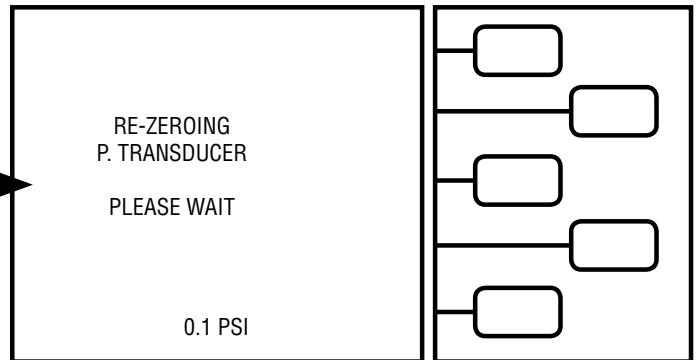

The Pressure Transducer (PT) calibration will automatically complete the procedure.
Once done, the LCD will return to the **Main Menu**:

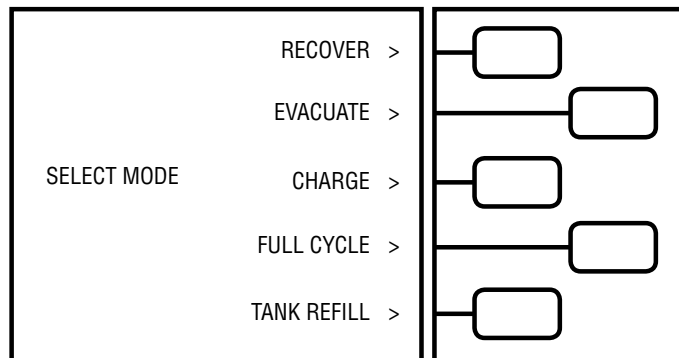

MAINTENANCE

CHANGE REFRIGERANT:

Push the **CHANGE REF** key

The LCD will have a list of refrigerants. Push the key next to the refrigerant for selection.

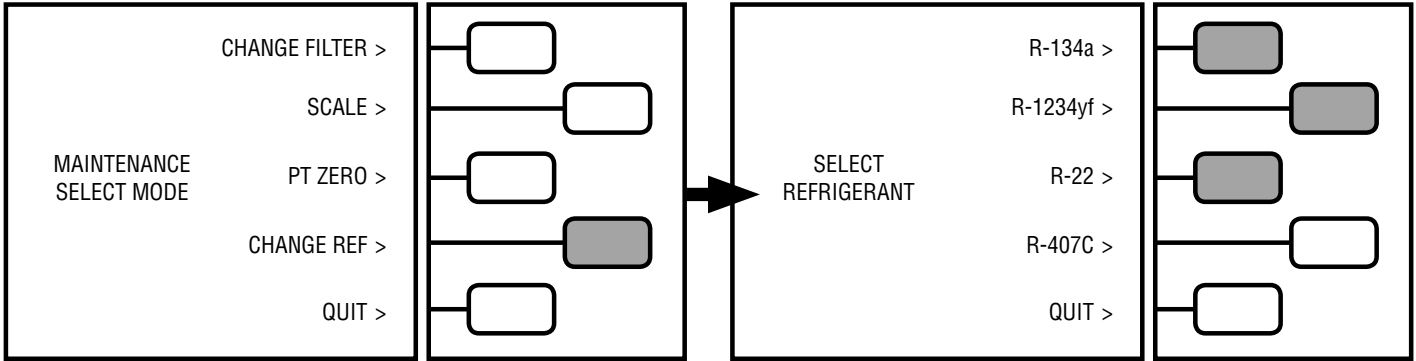

The LCD will show a message to CLOSE VALVE 1. Then push the **CONTINUE** key. The compressor will run for about 1 minute. HI and LO gauges will pull into a slight vacuum.

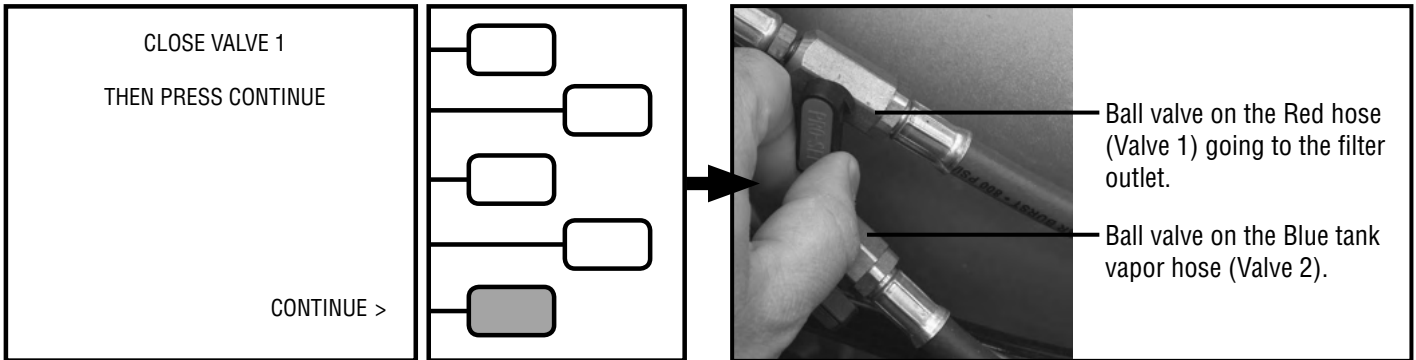

The LCD will show a message to CLOSE VALVE 2. Then push the **CONTINUE** key. The vacuum pump will run for about 3-5 minutes. HI and LO gauges will pull into a deep vacuum. Once done the LCD will read CHANGE TANK & HOSE.

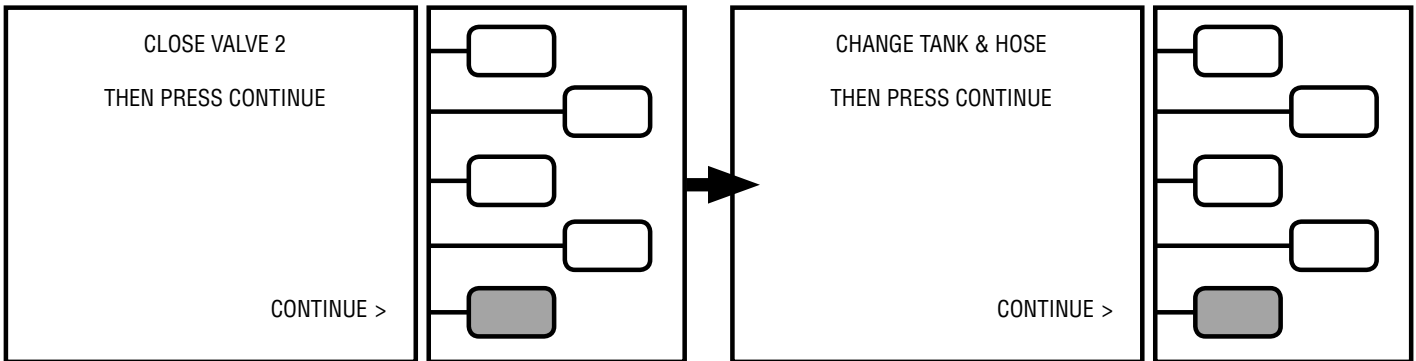

CHANGE REFRIGERANT (continued):

Remove the tank hose service cover using a 9/16" wrench, disconnect the tank hoses from the bulk head fittings on the back of the unit. Disconnect the ground wire clamp from the tank. Remove the entire tank/filter /hose assembly from the back of the unit. It will be necessary to use CPS kit FA1234X1 (50 lb tank/filter/hose assembly) for additional refrigerants. Place either a new pre-evacuated 50 lb tank/filter/hose assembly or an existing one on the scale platform. Connect the tank Red hose to upper bulk head fitting. Connect Blue tank hose to lower bulk head fitting. Reconnect ground wire clamp to tank.

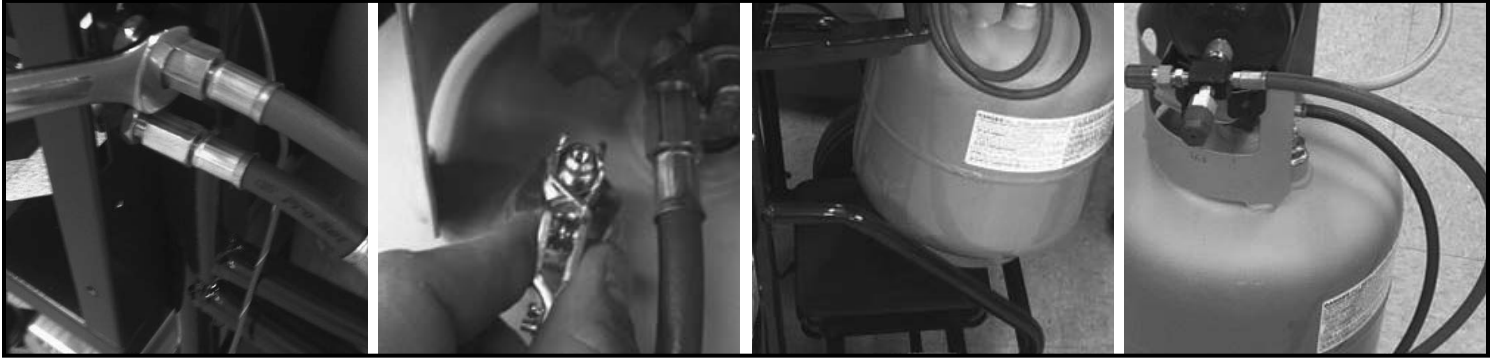

Remove the service hose cover. Install the correct service hoses for the refrigerant selected.

- The unit comes with the R-1234yf service hoses.
- For R-22 or R-407 refrigerant selection, purchase CPS hoses (HP8RE and HP8BE).

Once done, re-install the service hose cover.

Push the **CONTINUE** key. The unit will proceed to do the automatic PT (Pressure Transducer) calibration and then (if required) the air purge. This should only take a few minutes and once complete the **Main Menu** will appear on the LCD.



If there are any questions on confirming the refrigerant selected, turn OFF the unit. Then turn the unit ON. The LCD will briefly show the current refrigerant selected.

The LCD will have a list of refrigerants. Push the Key next to the refrigerant selection.

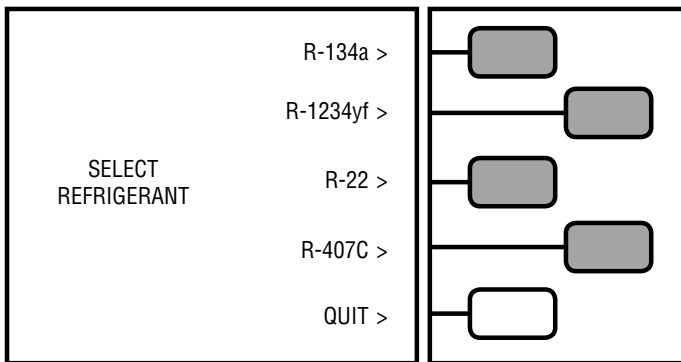

Maintenance - Interconnecting Hoses, Service Hoses and Couplers:

The FA1234 uses brass to brass seal type fitting on the ends of the service hoses and interconnecting hoses. No hose gasket maintenance is required on brass to brass type connections. The fittings connecting to the filter drier do use a rubber hose gasket. When changing the filter drier, check the gaskets for wear. Replace if required. Periodically inspect all refrigerant hose assemblies, service hoses and both service coupler inner o-rings for wear. Replace the component(s) if excessive wear or leakage is observed. Periodically leak-check all hose connection points, hose ball valves, and service couplers. Since the unit does pull a vacuum in the recovery process, excessive Non-Condensable Gases (NCG's) could be sucked into the system and placed in the storage tank.

SERVICE PARTS AND ACCESSORIES

Item	Description
39-020	115V 6" Fan
39-021	230V 6" Fan
54-100	Spare oil bottle
AR2788SX3	Scale module
AR2788SX11	AR2788S / FA1234 tank liquid to filter IN hose
AR2788SX17	Black scale patch cord
AR2788SX18	Red relay PCB patch cord
AR2788SX19	Yellow Low side block PCB patch cord
AR2788SX20	Green High side block PCB patch cord
AR2788SX21	Low side block PCB
AR2788SX22	High side block PCB
AR2788SX23	Main PCB
AR2788SX24	LCD
AR2788SX28	Oil injection assembly
AR2788SX29	Tank filter bracket / straps
AR2788X14a	1/2" ACME tank refill adaptor
AR2788X16	Low side gauge kit
AR2788X17	High side gauge kit
AR2788X25	Scale PCB
AR2788X28	Power supply
AR2788X30	1lb. check weight
AR2788X32	15 AMP breaker 115 VAC
AR2788X33	10 AMP breaker 240 VAC
AR2788X34	ON / OFF momentary switch
AR2788X40	6 ft. power cord 115 VAC
AR2788X41	6 ft. power cord 240 VAC (Europe)
AR2788X45	High pressure switch 450 PSI
AR2788X46	Pressure transducer
AR2788X53	IEC heater blanket / vacuum pump outlet
AR2788X57	Gauge line repair kit
AR2788X64	Castor with brake
AR2788X65	10" wheel
AR27XHB15	115 volt 300 watt heater blanket
AR27XHB230	230 volt 300 watt heater blanket
ARXF5	Coded 41 cu in filter
FA1234X2	FA1234 compressor assembly 115V
FA1234X3	FA1234 compressor assembly 230V 50 Hz.
FA1234X6	AR2788S II / FA1234 Low side block complete
FA1234X7	FA1234 High side block complete
FA1234X4	FA1234 compressor assembly 100V
FA1234X5	AR2788 II / FA1234 oil drain bottle assembly
FA1234X6	AR2788 II / FA1234 Low side block complete
FA1234X7	FA1234 High side block complete
FA1234X8	FA1234 DOA chamber

Item	Description
FA1234X9	FA1234 High side service hose
FA1234X8	FA1234 DOA chamber
FA1234X9	FA1234 High side service hose
FA1234X10	FA1234 Low side service hose
FA1234X13	AR2788S II / FA1234 discharge tank hose
FA1234X14	AR2788S II / FA1234 R-134A filter / tank hose
FA1234X15	AR2788S II / FA1234 HFO filter / tank hose
FA1234X16	AR2788S II / FA1234 vacuum pump hose
FA1234X17	FA1234 DOA out comp suction hose
FA1234X18	FA1234 comp discharge DOA HX IN hose
FA1234X19	FA1234 DOA HX OUT-HV1 tee hose
FA1234X20	FA1234 DOA oil drain HV3 hose
FA1234X21	FA1234 DOA IN tee (AUX) HS1 purge hose
FA1234X22	FA1234 HV1 tank vapor bulk head hose
FA1234X23	FA1234 LS1 tank liquid bulk head hose
FA1234X24	FA1234 HV1 tee HV2 hose
FA1234X25	FA1234 HV3 oil drain bulk head hose
FA1234X26	FA1234 LV3-HV2 tee VAC hose
FA1234X27	FA1234 LV4 (Regulator) DOA IN tee hose
FA1234X28	AR2788 II / FA1234 four relay PCB
FA1234X29	FA1234 temp. sensor internal tank vapor line
FA1234X30	AR2788 II / FA1234 temp. sensor ambient
FA1234X32	Air flow sensor
FA1234X33	FA1234 key pad
FA1234X34	FA1234 R-134A coupler storage fittings set
FA1234X35	FA1234 HFO-1234yf coupler storage fittings set
FA1234X36	FA1234 HFO refill hose
FA1234X37	Regulator - 80 PSIG
FA1234X38	FA1234 main PCB
FA1234X39	IEC main power inlet
FA1234X92	92 lb tank / filter / hose kit for additional ref.
QCH123414	HFO-1234yf High side service coupler (14mm)
QCL123414	HFO-1234yf Low side coupler (14mm)
QCH134	R-134A High side coupler
QCL134	R-134A Low side coupler
TR21X1	Compressor valve rebuild kit
TR21X2	Compressor complete rebuild kit
TR21X3	Compressor connector rod assembly (2X)
TR21X4	Compressor head assembly with valves
VP6S	6 CFM 50 micron vacuum pump
VPOG	1 gallon vacuum pump oil
VPXF15	Vacuum pump fuse
VPXODP	Vacuum pump oil drain plug
VPXOMP	Vacuum pump exhaust cap

HIGH VOLTAGE A/C CHARGING INSTRUCTIONS

OEM manufacturers of Automotive High Voltage A/C systems have required that the residual amount of PAG oil in the charging hose(s) be reduced to a minimal level. The following are instructions on how to prepare the FA1234 for charging a High Voltage A/C system:

- Step 1: Remove the oil injection assembly from the FA1234 injection port. Cap off this port.
- Step 2: Push the **REFILL** key. Do not hook up the service hoses as instructed by the LCD.
- Step 3: Push the **START** key. Run until **RESUME** and **QUIT** keys come up on the LCD.
- Step 4: Connect both **HI** and **LO** service hoses to the auxiliary fittings (**a-b**) on the hose between the filter and tank liquid port as shown in **Fig 3**.
- Step 5: Push the **RESUME** key.
- Step 6: Open both **HI** and **LO** service coupler valves.
- Step 7: Run for 30 minutes.
- Step 8: After 30 minutes close both **HI** and **LO** couplers.
- Step 9: Allow the **REFILL** mode to complete the evacuation of the hoses.

The unit is now ready to charge a High Voltage A/C system. Following the CHARGING MODE instructions on page 13.

NOTE: When injecting oil back into a high voltage A/C system, use the OEM recommended oil. Purchase CPS injecting kit (AR2788X23) for additional injectors for different OEM oils.

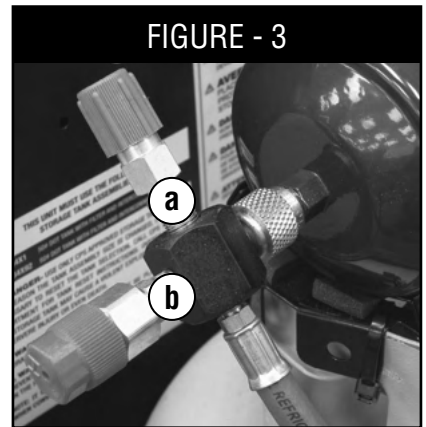

Connect service hoses to auxiliary ports on the liquid feed hose

TROUBLE SHOOTING

Problem: High Pressure Limit.

Solution: Check that both Storage Tank valves are open. Check that any inline hose ball valves to the Storage Tank are open.

Problem: Tank Overfill.

Solution: Remove refrigerant from Storage Tank by charging into an empty refrigerant cylinder. If this does not fix the problem, then Re-Zero scale.

Problem: Unit not Charging accurately.

Solution: Make sure Storage Tank is properly placed on platform so that no portion of the tank is touching the back of the unit or protective frame work of the unit.

Solution: Do not move the unit while in the charging mode. The unit utilizes a weighing method of charging. Sudden movement of the storage tank will affect the charging accuracy.

Solution: Make sure unit is on a level surface. If placed on surface with more than 2% grade, the charging amount may be incorrect.

Problem: Unit will not power up.

Solution: Check to make sure circuit breaker on back of unit is not tripped. Reset and restart the unit if necessary.

Solution: Make sure power cord is plugged into the back of the unit and the wall receptacle.

Problem: Upon compressor start up, the circuit breaker trips.

Solution: Reset circuit breaker and try again.

Problem: Upon vacuum pump start up, the circuit breaker trips.

Solution: Check Oil Level in vacuum pump. Reset circuit breaker and try again.

Solution: Make sure vacuum pump voltage switch is in the correct position.

For other problems, please call the CPS service network for further instructions.

WARRANTY & REPAIR POLICY / CONTACT INFORMATION

WARRANTY & REPAIR POLICY

CPS guarantees that the Mach 7 is free of manufacturing and material defects for one year. If a component should fail during the guarantee period, it will be repaired or replaced (at our option) at no charge. This guarantee does not apply to components that have been altered, misused, or returned solely in need of field service maintenance. This repair policy does not include components that are determined to be beyond economical repair. A component being returned for warranty repair must be accompanied by an original bill of sale and customer contact information.

CPS Products, Inc.

1010 East 31st Street, Hialeah, Florida 33013, USA
Tel: 305-687-4121, 1-800-277-3808, Fax: 305-687-3743
E-mail: info@cpsproducts.com
Website: www.cpsproducts.com

CPS Canada LTD.

1324 Blundell Road, Mississauga, Ontario L4Y 1M5
Tel: 905-615-8620, Fax: 905-615-9745
E-mail: info@cpsproducts.com

CPS Products N.V

Krijgsbaan 241, 2070 Zwijndrecht, Belgium
Tel: (323) 281 30 40, Fax: (323) 281 65 83
E-mail: info@cpsproducts.be
Website: www.cpsproducts.be

CPS Australia PTY. LTD.

109 Welland Avenue, Welland, South Australia 5007
Tel: +61 8 8340 7055, Fax: +61 8 8340 7033
E-mail: sales@cpsaustralia.com.au



www.cpsproducts.com